

TESLA  
ENERGY



POWERWALL INSTALLATION MANUAL  
FOR POWERWALL 1067000-00-C WITH SMA AND SOLAREEDGE INVERTERS

For the latest Powerwall installation documents in all supported languages, go to:  
[www.teslamotors.com/support/powerwall-installer](http://www.teslamotors.com/support/powerwall-installer)

To secure the full 10-year product warranty for the owner, be sure to register Powerwall online.

**Warning:** Read this entire document before installing or using Powerwall. Failure to do so or to follow any of the instructions or warnings in this document can result in electrical shock, serious injury, or death, or can damage Powerwall, potentially rendering it inoperable.

#### PRODUCT SPECIFICATIONS

All specifications and descriptions contained in this document are verified to be accurate at the time of printing. However, because continuous improvement is a goal at Tesla, we reserve the right to make product modifications at any time.

The images provided in this document are for demonstration purposes only. Depending on product version and market region, details may appear slightly different.

#### ERRORS OR OMISSIONS

To communicate any inaccuracies or omissions in this manual, please send an email to: [energymanualfeedback@teslamotors.com](mailto:energymanualfeedback@teslamotors.com).

#### ELECTRONIC DEVICE: DO NOT THROW AWAY



Proper disposal of batteries is required. Refer to your local codes for disposal requirements.



MADE IN THE USA



©2016 TESLA MOTORS, INC. All rights reserved.

All information in this document is subject to copyright and other intellectual property rights of Tesla Motors, Inc. and its licensors. This material may not be modified, reproduced or copied, in whole or in part, without the prior written permission of Tesla Motors, Inc. and its licensors. Additional information is available upon request. The following are trademarks or registered trademarks of Tesla Motors, Inc. in the United States and other countries:

TESLA    TESLA MOTORS    **TESLA**    POWERWALL

All other trademarks contained in this document are the property of their respective owners and their use herein does not imply sponsorship or endorsement of their products or services. The unauthorized use of any trademark displayed in this document or on the product is strictly prohibited.



<b>Important Safety Instructions.....</b>	<b>2</b>
SYMBOLS IN THIS DOCUMENT.....	2
GENERAL INFORMATION.....	2
ENVIRONMENTAL CONDITIONS.....	3
<b>Specifications.....</b>	<b>4</b>
ELECTRICAL SPECIFICATIONS.....	4
ENVIRONMENTAL SPECIFICATIONS.....	4
MECHANICAL SPECIFICATIONS.....	4
<b>Site Requirements.....</b>	<b>5</b>
PHYSICAL REQUIREMENTS.....	5
TEMPERATURE REQUIREMENTS.....	5
INSTALLATION REQUIREMENTS.....	5
MINIMUM SPACE REQUIREMENTS.....	6
<b>Step-by-Step Installation Instructions.....</b>	<b>7</b>
REQUIRED TOOLS.....	7
STEP 1 - REMOVE THE LID AND BOTTOM COVER.....	8
STEP 2 - REMOVE THE SPLASH COVER.....	9
STEP 3 - SET THE COMMUNICATION SWITCHES.....	10
STEP 4 - SET THE ADDRESS SWITCHES.....	11
STEP 5 - PREPARE THE WIRING.....	12
STEP 6 - CONNECT THE WIRING.....	14
STEP 7 - ATTACH THE SPLASH COVER.....	16
STEP 8 - REMOVE THE PALLET.....	17
STEP 9 - DETERMINE THE MOUNTING LOCATION FOR POWERWALL.....	19
STEP 10 - INSTALL THE WALL MOUNT BRACKET.....	19
STEP 11 - MOUNT POWERWALL.....	20
STEP 12 - REMOVE THE PACKAGING.....	21
STEP 13 - FEED WIRES THROUGH THE CONDUIT PLATE OR CABLE GLAND.....	22
STEP 14 - CONNECT MULTIPLE POWERWALLS TOGETHER.....	23
STEP 15 - CONNECT POWERWALL TO THE INVERTER.....	23
STEP 16 - ATTACH THE SIDE COVERS.....	24
STEP 17 - ATTACH THE BOTTOM COVER.....	25
STEP 18 - REPACK THE SHIPPING BOX.....	25
<b>Operation and Care.....</b>	<b>26</b>
NORMAL OPERATION.....	26
POWERWALL CARE.....	26
TROUBLESHOOTING.....	26
<b>What to Do in Case of an Emergency.....</b>	<b>27</b>

# Important Safety Instructions













SAVE THESE IMPORTANT SAFETY INSTRUCTIONS. Powerwall installation and repair instructions assume knowledge of high voltage electricity and should only be performed by Tesla Energy Certified Installers. Tesla Motors assumes no liability for injury or property damage due to repairs attempted by unqualified individuals or a failure to properly follow these instructions. These warnings and cautions must be followed when using Powerwall.









## SYMBOLS IN THIS DOCUMENT

This manual uses the following symbols to highlight important information:





 Warning:	WARNING indicates a hazardous situation which, if not avoided, could result in injury or death.
 Caution:	CAUTION indicates a hazardous situation which, if not avoided, could result in damage to the equipment.
Note:	NOTE indicates an important step or tip that leads to best results, but is not safety or damage related.

## GENERAL INFORMATION

-  Warning: Read this entire document before installing or using Powerwall. Failure to do so or to follow any of the instructions or warnings in this document can result in electrical shock, serious injury, or death, or can damage Powerwall, potentially rendering it inoperable.
-  Warning: A battery can present a risk of electrical shock, fire, or explosion from vented gases. Observe proper precautions.
-  Warning: Powerwall installation must be carried out only by Tesla Energy Certified Installers, who have been trained in dealing with high voltage electricity.
-  Warning: Powerwall is heavy and challenging to lift.
-  Warning: Use Powerwall only with a Tesla-approved inverter. For a list of compatible inverters, go to:  
[www.teslamotors.com/support/powerwall](http://www.teslamotors.com/support/powerwall)
-  Warning: Use Powerwall only as directed.
-  Warning: Do not use Powerwall if it is defective, appears cracked, broken, or otherwise damaged, or fails to operate.
-  Warning: Before beginning the wiring portion of the installation, first power off the inverter and then open the AC and DC disconnect switches (if applicable for the installation).
-  Warning: Do not attempt to open, disassemble, repair, tamper with, or modify Powerwall. Powerwall is not user serviceable. Batteries in Powerwall are not replaceable. Contact the Tesla Energy Authorized Reseller who sold the Powerwall for any repairs.
-  Warning: Do not connect Powerwall to alternating current carrying conductors. Powerwall must be wired to either an inverter or a DC combiner panel that is then wired to an inverter. No other wiring configuration may be used.
-  Warning: To protect Powerwall and its components from damage when transporting, handle with care. Do not impact, pull, drag, or step on Powerwall. Do not subject Powerwall to any strong force. To help prevent damage, leave Powerwall in its shipping packaging until it is ready to be installed.
-  Warning: Do not insert foreign objects into any part of Powerwall.
-  Warning: Do not expose Powerwall or its components to direct flame.

-  Warning: Do not install Powerwall near heating equipment.
-  Warning: Do not immerse Powerwall or its components in water or other fluids.
-  Caution: Do not use cleaning solvents to clean Powerwall, or expose Powerwall to flammable or harsh chemicals or vapors.
-  Caution: Do not use fluids, parts, or accessories other than those specified in this manual, including use of non-genuine Tesla parts or accessories, or parts or accessories not purchased directly from Tesla or a Tesla-certified party.
-  Caution: Do not place Powerwall in a storage condition for more than one (1) month, or permit the electrical feed on the Powerwall to be severed for more than one (1) month, without placing Powerwall into a storage condition in accordance with Tesla's storage specifications.
-  Caution: Do not paint any part of Powerwall, including any internal or external components such as the exterior shell or casing.
-  Caution: Do not connect Powerwall directly to photovoltaic (PV) solar wiring.
-  Caution: When installing Powerwall in a garage or near vehicles, keep it out of the driving path. If possible, install the Powerwall on a side wall and/or above the height of vehicle bumpers.
-  Caution: Powerwall has a pre-installed aesthetic front cover. To prevent damage, keep Powerwall flat on its back until just before lifting Powerwall onto the wall mount bracket.

## ENVIRONMENTAL CONDITIONS

-  Warning: Install Powerwall at a height that prevents damage from flooding.
-  Warning: Operating or storing Powerwall in temperatures outside its specified range might cause damage to Powerwall.
-  Warning: Do not expose the Powerwall to ambient temperatures above 60°C (140°F) or below -30°C (-22°F).
-  Caution: Ensure that no water sources are above or near Powerwall, including downspouts, sprinklers, or faucets.
-  Caution: Ensure that snow does not accumulate on top of or around Powerwall.

## ELECTRICAL SPECIFICATIONS

Charge and Discharge Power, Peak and Continuous	3.3 kW
Energy <sup>1</sup>	6.4 kWh
DC Voltage	350 V to 450 V
DC Current, Maximum and Continuous	9.5 A
Round Trip DC Efficiency (Beginning of Life) <sup>1</sup>	92.5%

## ENVIRONMENTAL SPECIFICATIONS

Operating Temperature <sup>2</sup>	-20 °C to 50 °C (-4 °F to 122 °F)
Humidity	<95% non-condensing
Storage <=12 months	State of Energy (SoE): 25% initial
Noise (at Full Thermal System Performance)	<49 dBA front, and <55 dBA top, at a distance of 1m
Maximum Altitude	3000 m (9843 ft)
Ingress Rating	IP35 and NEMA 3R (Powerwall) IP67 (battery Pod only)
Impact Rating	IK09
Seismic Rating	AC156 and IEEE 693-2005

## MECHANICAL SPECIFICATIONS

Length	1302 mm (51.3 in)
Width	862 mm (34 in)
Depth	183 mm (7.2 in)
Weight	97 kg (214 lbs)

<sup>1</sup> Values provided for 25 °C, 2 kW charge/discharge power, 400 V to 450 V DC bus.

<sup>2</sup> Performance might be de-rated in extreme ambient temperatures.

## PHYSICAL REQUIREMENTS

Powerwall must be installed on an upright wall that can support 115 kg (254 lbs), the maximum weight of Powerwall and its installation packaging. The wall must be flush and extend to all edges of the system, allowing no access to the back of the unit once it is mounted. Do not mount Powerwall horizontally or upside down. Do not mount Powerwall on a wall that is tilted backward or forward more than 5 degrees.

Powerwall requires adequate clearance for installation, cabling, and airflow. Do not mount any other objects within the clearance space illustrated below, except those explicitly required by the installation (for example, conduit or DC disconnect depending on local installation codes). Do not install anything between Powerwall and the ceiling.

Note: Powerwall has a pump and fan that produce a gentle hum during operation, comparable to a typical refrigerator or dishwasher. This intermittent noise is normal and enables Powerwall to maintain ideal battery temperature. The noise level depends on the ambient temperature and the power level of operation. Choose the installation location of the Powerwall with due consideration for the owner's sensitivity to noise level.

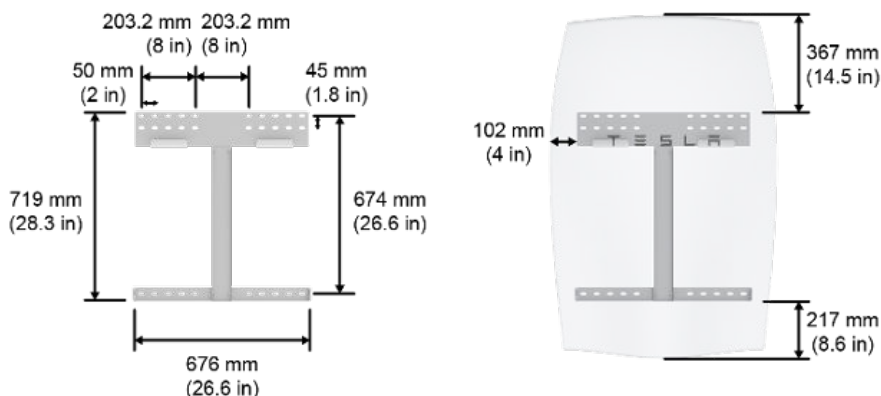

## TEMPERATURE REQUIREMENTS

Powerwall is capable of charging and discharging within the full ambient temperature range listed in the Specifications section. At the high and low ends of the temperature range, Powerwall may limit charge or discharge power based on battery cell temperature to improve battery lifespan.

Installation in full sun raises the temperature inside the enclosure above ambient temperature. This temperature rise is not a safety risk, but can impact the performance of the batteries. Installation in full sun is not recommended to optimize the use of Powerwall.

Do not install Powerwall in a room with sustained elevated temperatures, such as a boiler room. The average ambient temperature over the system's life should be 30°C (86 °F) or less.

## INSTALLATION REQUIREMENTS

Powerwall must be installed with a compatible inverter. Wiring and conduit (where necessary) must be provided by the installer.

DC disconnect requirements between Powerwall and the inverter are subject to local codes. Ensure that the installation meets local DC disconnect requirements. Check the inverter installation manual to understand site connections and overcurrent protection.

# Site Requirements

All U.S. and Canada electrical installations must be done in accordance with local codes and the National Electric Code (NEC) ANSI/NFPA 70 or the Canadian Electrical Code CSA C22.1.

All installations must conform to the laws, regulations, codes, and standards applicable in the jurisdiction of installation.

## MINIMUM SPACE REQUIREMENTS

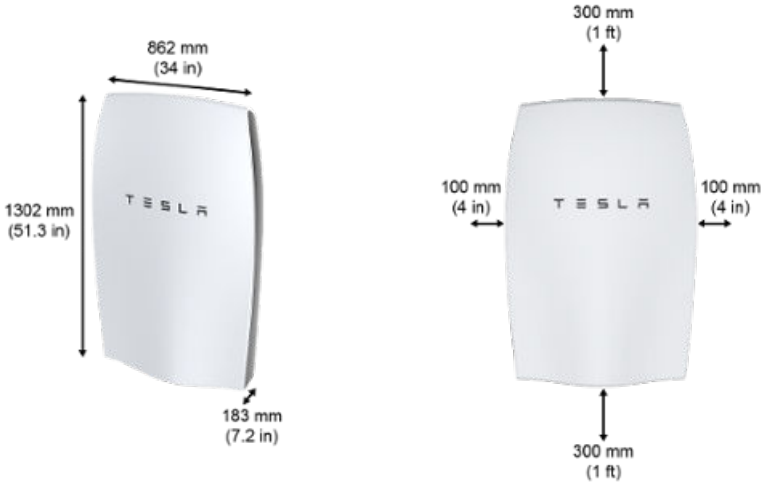

Total ceiling height	2000 mm (6.5 ft )
Clearance above	300 mm (1 ft)
Clearance below	300 mm (1 ft)
Lateral wall space	1070 mm (42 in)
Clearance from each side	100 mm (4 in)
Depth of workspace <sup>3</sup>	762 mm (30 in)

<sup>3</sup> Depth requirement is typically determined by working clearances required in the local installation code.



 Warning: Powerwall must be installed by a Tesla Energy Certified Installer.

STEP 1 - REMOVE THE LID AND BOTTOM COVER

STEP 2 - REMOVE THE SPLASH COVER

STEP 3 - SET THE COMMUNICATION SWITCHES

STEP 4 - SET THE ADDRESS SWITCHES

STEP 5 - PREPARE THE WIRING

STEP 6 - CONNECT THE WIRING

STEP 7 - ATTACH THE SPLASH COVER

STEP 8 - REMOVE THE PALLET

STEP 9 - DETERMINE THE MOUNTING LOCATION FOR POWERWALL

STEP 10 - INSTALL THE WALL MOUNT BRACKET

STEP 11 - MOUNT POWERWALL

STEP 12 - REMOVE THE PACKAGING

STEP 13 - FEED WIRES THROUGH THE CONDUIT PLATE OR CABLE GLAND

STEP 14 - CONNECT MULTIPLE POWERWALLS TOGETHER

STEP 15 - CONNECT POWERWALL TO THE INVERTER

STEP 16 - ATTACH THE SIDE COVERS

STEP 17 - ATTACH THE BOTTOM COVER

STEP 18 - REPACK THE SHIPPING BOX

## REQUIRED TOOLS

- Wall mount bracket fasteners

Note: The details below are only guidance and are not guaranteed to be applicable. Consult local building codes and a structural engineer to ensure the use of appropriate fasteners.

- Minimum of 6 fasteners, stainless steel, diameter 10 mm (3/8 in)
- Fastener head clearance for all positions but two bottom outer holes: 18 mm (11/16 in)
- Fastener head clearance for bottom two holes at 600 mm (24 in) spacing: 8 mm (5/16 in)
- Washers between fastener heads and wall mount bracket are recommended
- Drill and a drill bit suitable for drilling pilot holes in the desired mounting surface
- Socket wrench
- 10 mm socket adapter (for covers and wall mount bracket side tabs)
- 17 mm socket adapter (for wood block bolts)
- Large flathead screwdriver (for ground lug)
- Optional: small flathead screwdriver (for wiring terminal tabs)
- T20 Torx (for splash cover and screws fastening box to wood blocks)
- T30 Torx (for packaging L-bracket and conduit/gland plate)
- Torque wrench
- Stud finder (for wood installations)
- Level tool
- Painter's tape and/or pencil
- Wire stripper and wiring (as described in [Step 5](#))
- Conduit fitting or cable gland (as appropriate)
- Lift tool or adequate personnel trained and capable of lifting 115 kg (254 lb) from ground level to approximately chest height

 Warning: Powerwall is heavy and challenging to lift. Lift equipment is recommended.

To prevent injury, wear work boots (preferably steel-toed), long pants, and gloves.

## STEP 1 - REMOVE THE LID AND BOTTOM COVER

For easiest installation, pre-install wiring and set all switches while Powerwall is still on its pallet, as described below.

1. Lay the box flat on the ground with the pallet side down.



2. Use a T20 Torx to remove 8 screws from each box side. Do not remove the screws near the corners of the box.
3. Lift the box lid and set it aside.
4. Verify that the box contains the following items:

- Powerwall
- Wall mount bracket on the pallet under the unit (wall mounting fasteners are not included)
- Two side covers
- Two M6, 10 mm external hex bolts for the wall mount bracket side tabs (plus one spare bolt for side tabs or bottom cover)
- Spare M4, T20 bolt (if needed for splash cover)

If any parts are damaged or missing, contact the Tesla Energy Authorized Reseller or Tesla Energy Certified Installer. If any damage is detected, address high voltage and other safety risks immediately. Do not continue the installation procedure.

5. Use a 10 mm hex socket to remove a 10 mm external hex M6 screw on each side of the bottom cover.
6. Carefully slide off the bottom cover, ensuring that nothing is caught or bent.
7. Set the bottom cover and the 2 screws aside for reassembly after the wiring is complete.



## STEP 2 - REMOVE THE SPLASH COVER

**⚠ Warning:** Before beginning the wiring portion of the installation, verify that the inverter is powered off.

Note: When the splash cover is removed, an Enable circuit disables the internal electronics of Powerwall. Refer to the illustration in [Step 5](#) for the location of the Enable buttons.

**⚠ Warning:** Ensure the Enable buttons are not pressed by any wiring.

**⚠ Warning:** The Enable buttons only disable power from Powerwall. They do not disable power from the inverter.

1. Turn off power to the relevant area at the circuit breaker panel.
2. Turn off the inverter.
3. Open the DC disconnect switch (if applicable for the installation).
4. Use a multimeter to verify that the wires from the inverter to Powerwall are not live.
5. Use a T20 Torx driver to remove the two splash cover screws.
6. Carefully remove the splash cover. Ensure that nothing is caught or bent. Set the screws and cover aside for reassembly after the wiring is complete.

**⚠ Warning:** Use a multimeter to ensure no voltage is present on the terminals of the Powerwall circuit board.

7. Before fitting any wires, practice removing and re-fitting the splash cover. Keep the whole cover square to the unit as it is aligned with the mounting holes. Do not push in one side before the other.



## STEP 3 - SET THE COMMUNICATION SWITCHES

Communication switches are located on the lower right side of the board.

1. Refer to the inverter manual to determine:
  - Whether to use CAN or Modbus communication
  - Whether bias is required (if the system is using Modbus)
2. Set the CAN-Modbus switch:

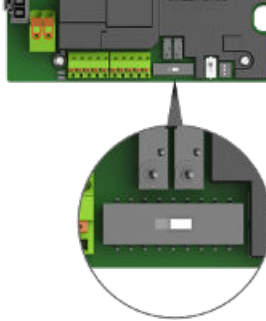

Inverter	Protocol	Switch Position
SMA	CAN	Left
SolarEdge	Modbus (RS485)	Right

3. Set the termination switch based on whether the installation is one unit or multiple units, and whether the system requires Modbus bias, per the table below.

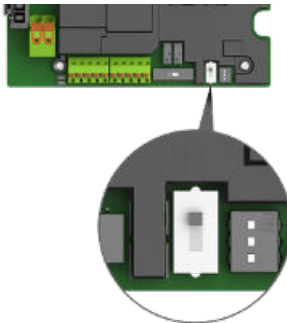

Inverter and Unit Position	Termination	Switch Position
SMA	Termination, NO Modbus bias	Top
SolarEdge, multi-unit other than the last	No termination	Middle
SolarEdge, single or last unit	Termination WITH Modbus bias	Bottom

## STEP 4 - SET THE ADDRESS SWITCHES

The DIP switch block has three white pins numbered "1", "2", and "3" from top to bottom with a value of '1' to the left and '0' to the right. Use these switches to set the Powerwall address.

Set the switches according to each Powerwall's position, per the table below. Set a single Powerwall using Powerwall 0 settings.

Note: Always check with the inverter partner for inverter abilities and instructions before connecting multiple Powerwalls.

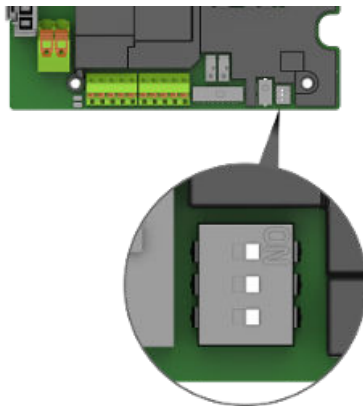

Address Switches	Powerwall 0	Powerwall 1
Switch 1	Right	Left
Switch 2	Right	Right
Switch 3	Right	Right

These switch settings create the addresses below for each unit.

Protocol	Powerwall 0 Address	Powerwall 1 Address
Modbus	24	25
CAN	80	81

## STEP 5 - PREPARE THE WIRING

Refer to local building and electrical codes when selecting appropriate wire gauge and length. Cut the ends of the wires to have clean, even ends. Strip the ends of the wires enough to make solid contact in the connector, while ensuring that no bare wire extends beyond the connector edge.

To ensure that installation is as simple as possible, select flexible wires with the smallest overall approved diameter. The wiring compartment is relatively small and the use of small diameter wires significantly speeds and simplifies the installation process.

A single 12 V power connection is required to power the logic. The Logic 12 V might be called "Logic," "Always On," "Communication," or similar.

 **Caution:** Do not splice wiring inside Powerwall.

 **Caution:** Do not add extra wiring to the left of the conduit or gland entry. Additional wiring may interfere with water ingress and high voltage shielding to the pump.

**Note:** Use shielded twisted pair communication wire and ground the shielding at one end. This reduces the possibility of noise on the communication cable. Do not ground the shield at both ends, which would create a ground loop.

**Note:** The 450 VDC cable is run in close proximity to the low voltage and communication cabling. Therefore, ensure that all cables to Powerwall are:

- Wet or oil rated
- At least 600 V insulation class

If low voltage and communication wires do not already meet these requirements, 600V insulation class heat shrink can be added around the bundle during installation.

# Step-by-Step Installation Instructions

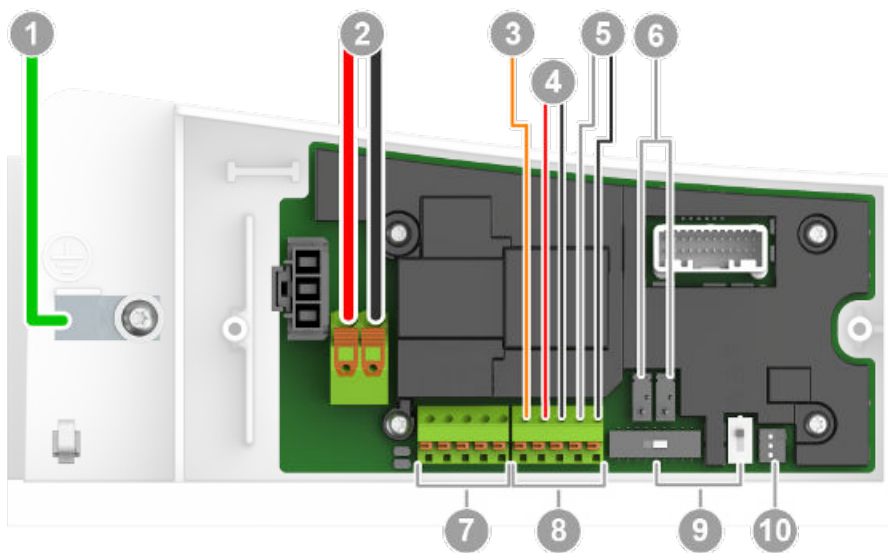

	Wire Type	Port Label	Wire Gauge	Strip Length
1	Ground/earth		2.5-6 mm <sup>2</sup> (14-10 AWG), 60 °C	8 to 12 mm
2	DC power + DC power -	+ tab - tab	2.5-6 mm <sup>2</sup> (14-10 AWG), 60 °C	12 to 16 mm
3	Enable line	ENABLE	0.2-1 mm <sup>2</sup> (24-18 AWG), 60 °C	7 to 9 mm
4	Logic power Logic return	LOGIC+ LOGIC-	0.2-1 mm <sup>2</sup> (24-18 AWG), 60 °C	7 to 9 mm
5	Negative communication Positive communication	COM HI COM LO	0.2-1 mm <sup>2</sup> (24-18 AWG), 60 °C	7 to 9 mm
6	Enable buttons (disable power when splash cover is off)			
7	Output connector for multiple units (J6)			
8	Primary connector (J7)			
9	Communication switches			
10	Address switches			

Note: Powerwall 1067000-00-C does not require separate wiring for thermal power.

## STEP 6 - CONNECT THE WIRING

Refer to the numbers on the previous wiring table and image. The plastic cover over the board has raised printing on it that names each terminal.

1. Loosen the chassis ground screw terminal (1) with a flathead screwdriver.
2. Insert the ground/earth wire beneath the lug screw from the left side. Torque according to the wire size:
  - 2.5-5 mm<sup>2</sup> (14-12 AWG): 4.0 Nm (35 lbf-in)
  - 6-8 mm<sup>2</sup> (10-8 AWG): 4.5 Nm (40 lbf-in)

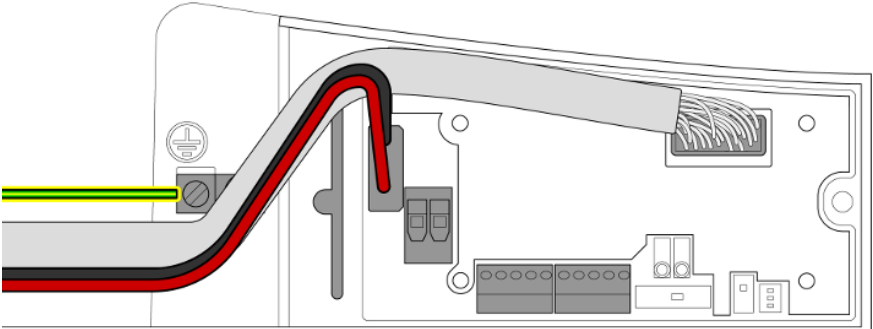

3. Pull both high voltage locking tabs on the spring terminal (2) away from the board to open them.  
Note: New tabs can be difficult to close. Close and open each tab once without wires before installation.
4. Route the positive (+) and negative (-) DC power wires behind the red and black internal DC wires, and fully insert them into the spring terminal tabs. The left slot is Positive and the right slot is Negative.

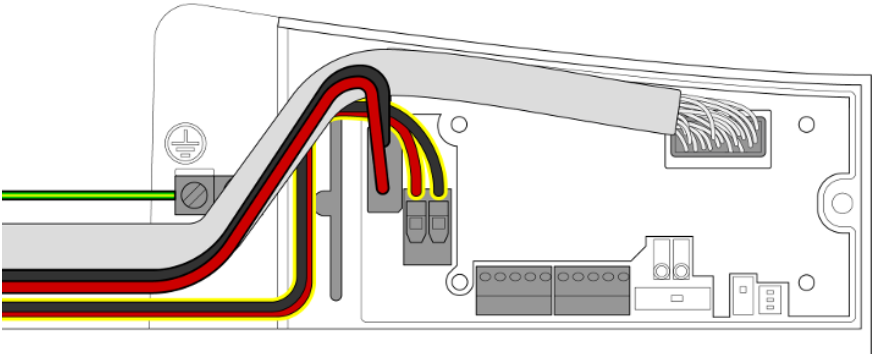

5. Close the locking tabs by pushing them up, so that the tab is flush with the connector. Close tabs one at a time. Lightly tug on each of the HV wires to ensure it is secure. If any wire must be removed, pull the locking tab open, then pull out the wire.



- ⚠ Warning:** Verify that both High Voltage tabs are locked completely shut over the wires (the image shows the correct position). The tabs have an intermediate position that shuts halfway, which is NOT electrically safe.



6. Route all data wires behind the red and black internal DC wires and in front of the field-installed DC power wires, toward the J7 connector. Insert each J7 wire (3, 4, 5) into its port as described in the wiring table above. If any J7 wire must be removed, gently push down on the appropriate button with a small screwdriver, then pull the wire out.

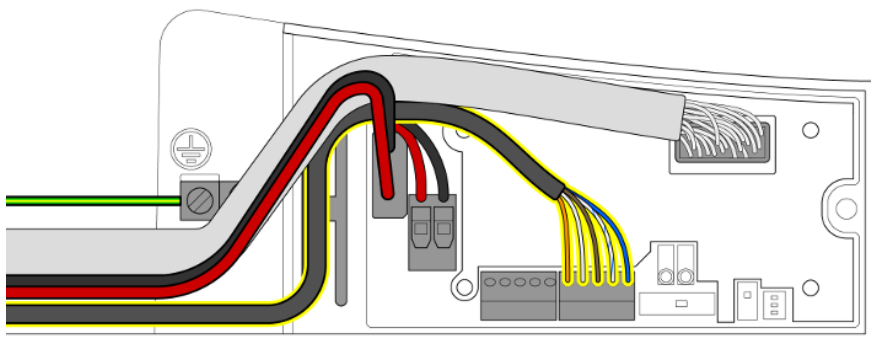

7. Lightly tug on every field-installed wire separately, to ensure it is seated properly.  
8. Verify that the polarities of all power and communication cables are correct.

All wires are now connected, leaving the communication connector (J6) on the left unused. If installing multiple Powerwalls, communication wires can be daisy-chained as described in [Step 14](#).

## STEP 7 - ATTACH THE SPLASH COVER

1. Route all wires toward the top left of the circuit board to keep them away from the Enable buttons. When the splash cover is removed, the Enable buttons disable power to the unit for service.

**⚠ Warning:** Misrouted wiring that keeps the buttons pressed in when the cover is off can create a risk of electric shock. Ensure that the Enable buttons are not pressed by any wiring.

2. Route all field-installed wires into the channel to the left of the splash cover mounting hole.

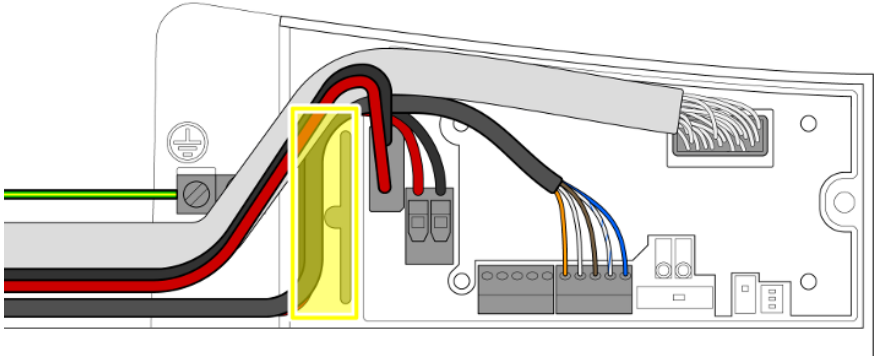

3. Align the splash cover with the circuit board.
4. Ensure that all wires route out of the splash cover through its side opening, and that wires are not pinched or kinked.
5. Ensure that the Enable buttons are pressed when the cover is attached. Listen for the click of the buttons being pressed.
6. Use a T20 Torx driver to attach the splash cover with two M4 screws. Torque to 3 Nm (27 in-lbs).
7. Use the included “fir tree” zip tie (in the exterior shipping pouch with the manual) to secure all field wires to the existing hole in the metal bracket. If the fir tree zip tie is already installed around the internal factory wiring, use a second zip tie to secure the field wiring to the internal wiring harness in the same location.

**⚠ Caution:** To ensure that wires do not interfere with fitting the splash cover or bottom cover, both factory wires and field wires must follow the route shown in images and be fastened in place with zip ties. Improper cover installation can nullify the ingress rating for Powerwall.

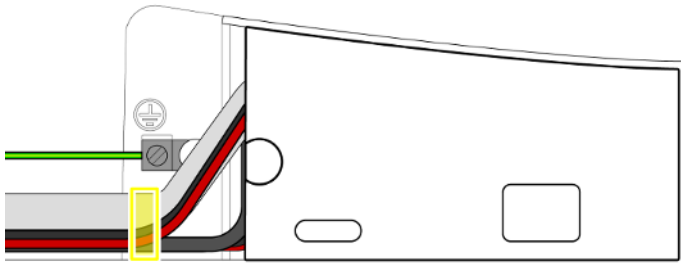

## STEP 8 - REMOVE THE PALLET

**⚠** Caution: Reinstall the front cover of the box for structural stability while lifting.

Note: Two people are needed for this procedure.

1. Place the box lid carefully back over Powerwall and move it sideways until the inside of the box lid touches the top edge of Powerwall. This leaves room for the bottom of the box to flex without damaging Powerwall's bottom cover.
2. Align the lower edge of the box between the upper and lower wood blocks on the sides of the Powerwall.

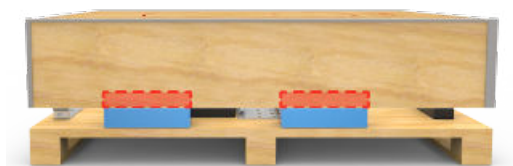

3. Use a T20 Torx to securely reinstall 2 screws into each of the 4 upper blocks attached to the sides of the Powerwall (8 screws total). Now the Powerwall is secured to the sides of the box with the top blocks, and the bottom blocks remain with the pallet.
4. Tuck all wiring into the box lid to avoid pinching or pulling the wires.
5. With one hand on the front cover and one hand under the pallet towards the top corner, both installers carefully tilt the box up onto its bottom end so that the Powerwall is standing right side up. Ensure the box is in a stable location, such as against a wall, where it will not be bumped or tip over.

**⚠** Caution: Never leave a Powerwall unattended while it is in a standing position.



6. Remove the pallet. The mounting cleat on the back of Powerwall should now be visible, and extend past the edge of the box for easy installation.



7. Remove the wall mount bracket from the inside face of the pallet.

## STEP 9 - DETERMINE THE MOUNTING LOCATION FOR POWERWALL

1. Using the wall mount bracket as a guide, measure the proposed location for Powerwall. The bracket must be bolted into studs or a load-bearing wall, and allow clearance on all sides as shown in [Site Requirements](#).
2. If mounting into wood, use a stud finder to locate and mark the center of the wooden studs. It is important to install each fastener as close to the middle of each stud as possible.
3. Position the thicker part of the bracket at the top, so that the flat side is flush with the wall. Use the bracket as a guide to mark the location of the holes on the wall. Space the holes 200, 300, 400, 500, or 600 mm (8, 12, 16, 20, or 24 in) apart.

Note: Use a level tool to ensure that the bracket is level.

## STEP 10 - INSTALL THE WALL MOUNT BRACKET

1. Drill the pilot holes to attach the wall mount bracket to the wall.
2. Install at least four washers and fasteners into the top part of the bracket and two washers and fasteners into the bottom of the bracket. There must be at least one fastener in each of the six mounting hole rows. Install the fasteners in the order shown in the numbered image.

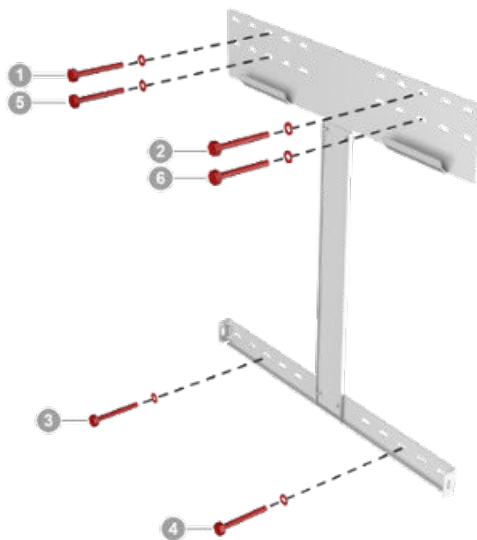

3. Verify that the bracket is firmly attached to the wall.
4. For easier alignment while lifting, use tape or a pencil to mark:
  - The wall at the height of the bracket lip, on the outside edges of the intended mount point
  - The Powerwall box sides, at the level of the mounting cleat
  - The centerlines of both the box and the bracket

## STEP 11 - MOUNT POWERWALL

1. With Powerwall still in its box, keeping it as level as possible, lift it so that the mounting cleat is just above the lip on the wall mount bracket. Use the tape or pencil marks on the wall as visual guides.

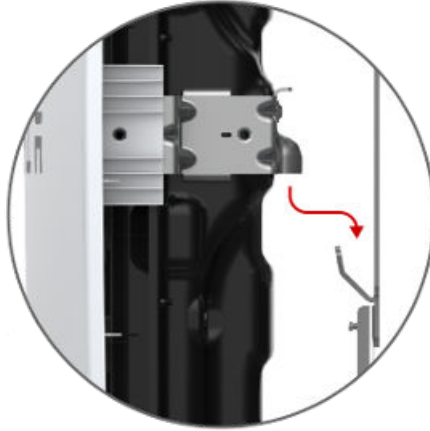

2. Lower Powerwall so that the cleat on the back of Powerwall fits securely over the lip on the bracket.
3. Ensure that Powerwall is centered on the bracket. When properly centered, Powerwall sits between the two protruding tabs on the bottom part of the bracket.



## STEP 12 - REMOVE THE PACKAGING

Note: Two people are needed for this procedure.



1. First person: Hold the box in place from the bottom edge, to prevent the box from slipping and damaging Powerwall's front cover.
2. Second person: Use a T20 Torx to remove the 8 screws holding the box to the wooden blocks.
3. Being careful not to bump the box into the sides or edges of Powerwall's front cover, remove the box and carefully set it aside.

Note: Leave the protective sticker on the Powerwall front cover until installation is complete.

4. Use a 17 mm socket to remove the 4 bolts that hold the wooden spacer blocks against the sides of Powerwall. Remove all 4 wooden blocks.
5. Use a T30 Torx driver to remove the screws from the metal L-brackets and discard.
6. Use a 10 mm socket tool and the 2 provided M6 external hex bolts to secure Powerwall to the lower tabs of the wall mount bracket. Torque to 7 Nm (62 in-lbs).



## STEP 13 - FEED WIRES THROUGH THE CONDUIT PLATE OR CABLE GLAND

Depending on regional requirements, Powerwall can be installed either through conduit or through a cable gland. Follow local codes to determine which is appropriate.

The conduit plate hole has a 28.2 mm (1.11 in) diameter. It supports  $\frac{3}{4}$ " trade fittings, and PG-21 and M25 glands. The conduit plate has passed water ingress testing with individual cables squeezed together in a single gland. All fittings other than the conduit plate itself are provided by the installer.

The access point on Powerwall is centered on the bottom of the device.

1. Use a T30 Torx driver to remove the conduit plate.



2. For conduit configurations, feed the wires through the conduit and conduit opening. Make sure that wires are not frayed.
3. For cable gland configurations, push out the protective coverings and feed the wires through the gland. Make sure that wires are not frayed.
4. Tighten the gland or conduit opening to the housing plate.
5. Reattach the conduit plate to Powerwall and torque to 7 Nm (62 in-lbs).



## STEP 14 - CONNECT MULTIPLE POWERWALLS TOGETHER

If the site is installing multiple Powerwalls, follow these instructions for wiring the units. If not, skip to the next step.

 **Caution:** Do not splice wiring inside Powerwall.

**Note:** Ensure that the multi-Powerwall installation meets local requirements for DC disconnects and correctly rated overcurrent protection.

**Note:** Always check with the inverter partner for inverter abilities and instructions before connecting multiple Powerwalls.

1. Remove the splash cover as described above.
2. Verify that the communication and address switch settings for each Powerwall in the chain are accurate as described in the above steps.
3. Connect the wiring coming from the inverter (communications +/-, enable line, and 12V Logic +/- wires) to the J7 connector as the primary connector.
4. Connect the output communications, enable, and 12V logic wiring going toward the next Powerwall to the J6 connector (see previous circuit board image). Powerwall allows daisy chaining of low voltage and communication cables.
5. Run DC power wiring independently to each Powerwall. Fuse each Powerwall individually.
6. Reinstall the splash cover.

## STEP 15 - CONNECT POWERWALL TO THE INVERTER

Run the wires between Powerwall and the inverter as described in the inverter manual. Follow local electrical installation codes for wire installation.

**Note:** Ensure that the installation meets local requirements for DC disconnects and correctly rated overcurrent protection.

## STEP 16 - ATTACH THE SIDE COVERS

**⚠** Caution: Failure to install the side covers using the proper steps might result in permanent damage to the covers.

1. Remove the side covers and the bag of enclosed fasteners from the shipping box.
2. Position the first side cover to the side of Powerwall that matches its curve.
3. Angle the back edge (side closest to the wall) in toward Powerwall.
4. Insert the top edge of the cover, then push in to fasten the top spring clip.
5. Fasten the bottom spring clip second, for easiest fit.
6. Fasten the middle spring clip. Verify that the entire length of the side cover is tucked completely under the edge of the front cover.
7. Repeat the installation steps on the opposite side for the other side cover.

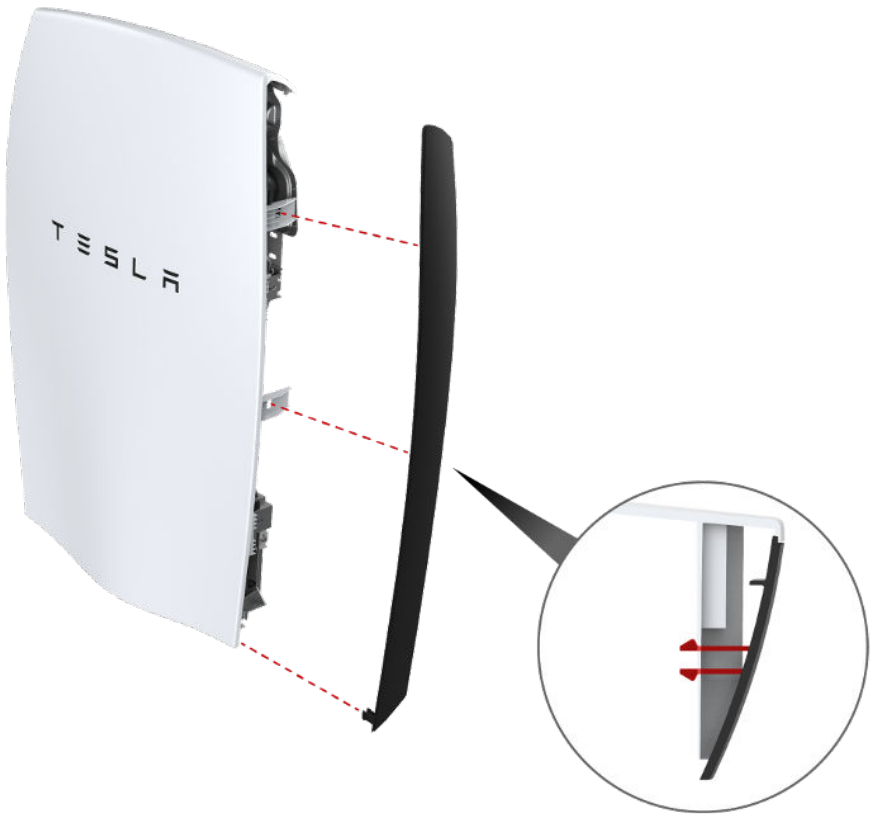

## STEP 17 - ATTACH THE BOTTOM COVER

1. Line up the bottom cover with the bottom of Powerwall, between the side covers.
2. Tuck the back edge of the bottom cover (closest to the wall) under the metal edge of the Powerwall body.
3. Route the wires from the conduit plate or gland back (toward the wall) below the ground/earth lug, then forward again to match the internal wiring harness path under the splash cover into the circuit board. Verify that the wires are not pinched or kinked by the internal edge of the bottom cover.

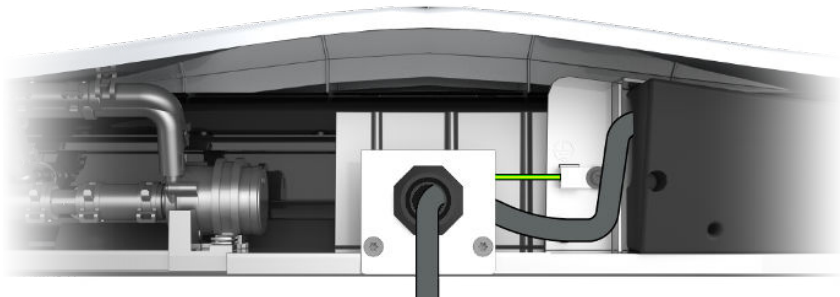





4. Close the bottom cover carefully over the wiring. Verify that the edge of the bottom cover is tucked completely under the lip of the front cover.
5. Use a 10 mm hex socket to attach the bottom cover with an M6 screw on each side. Torque to 3 Nm (27 in-lbs).
6. Once installation is complete, gently peel the protective sticker from Powerwall's front cover.

## STEP 18 - REPACK THE SHIPPING BOX

All Powerwall packing material is recyclable. To facilitate this process, place the packing materials into the shipping box in reverse order and return the shipping box to the Tesla Energy Authorized Reseller, or recycle onsite as appropriate.

## NORMAL OPERATION

During normal operation, Powerwall is completely controlled by the inverter. If Powerwall and the inverter are installed correctly, the inverter can turn on Powerwall, begin communications, then begin to process power commands. See the inverter manual for further configuration instructions.

-  Warning: Do not operate Powerwall unless all covers are in place.
-  Warning: Do not disconnect anything from or add anything to Powerwall.
-  Caution: Do not try to communicate with Powerwall using third party tools or diagnostics between Powerwall and the inverter.
-  Caution: Do not lean on, stack anything on top of, or hang anything from Powerwall or the conduit.

## POWERWALL CARE

Keep the top edge of Powerwall clear of leaves and other debris if installed outside, to maintain optimal airflow.

To clean Powerwall, use a soft, lint-free cloth. The cloth can be dampened with only water if needed.

-  Caution: Do not use cleaning solvents to clean Powerwall.

## TROUBLESHOOTING

If Powerwall is not working correctly, perform the following steps. Powerwall is not user serviceable and must be repaired by a Tesla Energy Certified Installer who has been trained by Tesla.

- Check the screen or portal of the inverter to look for fault codes and descriptions.
- If Powerwall refuses to operate: check the temperature in the room and increase ventilation if needed.
- If the inverter and Powerwall are both unresponsive:
  1. Switch off the inverter (if it has a switch).
  2. Switch off the AC and DC breaker(s) (if applicable) for the inverter.
  3. Wait for at least one minute.
  4. Turn AC and DC breakers back on (if applicable).
  5. Turn the inverter back on.
- If a brownout or blackout is experienced during backup: reduce the loads and check that the breakers have not opened.
- If it is not possible to communicate with the inverter through its portal: ensure that the home Internet connection is working.
- Follow the troubleshooting steps outlined in the inverter manual for both Powerwall and the overall system.

If the issue persists, contact the Tesla Energy Authorized Reseller who originally sold the Powerwall.

# What to Do in Case of an Emergency

In the event of any threat to health or safety, always begin with these two steps before addressing the other suggestions below:

1. Immediately contact the fire department or other relevant emergency response team.
2. Notify all people who might be affected and ensure that they are able to evacuate the area.

**⚠ Warning:** Only perform the suggested actions below if it is safe to do so.

- In case of a fire:
  - Switch off the inverter (if it has a switch), then the AC breaker to the inverter.
  - If a disconnect exists, switch off the DC disconnect on the inverter.
  - Acceptable fire extinguisher types are water, CO<sub>2</sub>, and ABC. Avoid type D (flammable metal) extinguishers.
- In case of flooding:
  - Stay out of the water if any part of the battery, inverter, or wiring is submerged.
  - Switch off the inverter (if it has a switch), then the AC breaker to the inverter.
  - If a disconnect exists, switch off the DC disconnect on the inverter.
  - If possible, protect the system by finding and stopping the source of the water, and pumping water away.
  - Let the area dry completely before use.
- If there is an unusual smell or smoke:
  - Switch off the inverter (if it has a switch), then the AC breaker to the inverter.
  - If a disconnect exists, switch off the DC disconnect on the inverter.
  - Ensure nothing is in contact with Powerwall.
  - Ventilate the room.
  - Contact the Tesla Energy Authorized Reseller who sold the Powerwall.
- If Powerwall is leaking coolant:
  - ⚠ Warning:** According to the U.S. Environmental Protection Agency, coolant can be absorbed through the skin and cause damage to internal organs. Ensure that it does not touch or enter any part of the body including, but not limited to, skin, eyes, and mouth.
  - Switch off the inverter (if it has a switch), then the AC breaker to the inverter.
  - If a disconnect exists, switch off the DC disconnect on the inverter.
  - Ventilate the area.
  - Contact the Tesla Energy Authorized Reseller who sold the Powerwall.

When cleaning up spilled coolant:

- Wear safety goggles, rubber gloves, pants, a long sleeved shirt, and fully closed shoes.
  - Avoid further coolant spill by putting a bucket under the leak. Powerwall holds up to 1.6 L (1.69 qt) of coolant.
  - Pour cat litter, sawdust, or another absorbent material on the spill immediately. Allow the material to absorb as much of the coolant as possible.
  - Use paper towels to collect the material that was used and discard the soiled paper towels in a sealed plastic bag. Place the sealed plastic bag into the garbage.
  - Clean up anything that remains using soap and warm water.
- If Powerwall is making unusual noises:
    - Switch off the inverter (if it has a switch), then the AC breaker to the inverter.
    - If a disconnect exists, switch off the DC disconnect on the inverter.
    - Ensure that nothing is in the vent on top of Powerwall or in the fan.
    - If nothing was found, contact the Tesla Energy Authorized Reseller who sold the Powerwall.

**TESLA**

3500 Deer Creek Road  
Palo Alto, CA 94304