

Sunny Boy

SWR 2500U

Installation and Operator's Manual

Issue 1.2

Grid Tied String Inverter for Photovoltaic Systems

Document- Number SB2500U	Issue and Alteration Review ¹⁾		Comments	Author
-11:EE4900	0.1	A	UL version, preliminary0	P. Simon
-11:NE1201	0.2	A	Split UL version, preliminary	P. Simon
-11:NE2001	1.0	A	Update	P. Simon
-11:NE2301	1.1	A	Update	P. Simon
-11:NE3801	1.2	A	Update	P. Simon

¹⁾ A: Changes due to faulty documents or improvement of the documentation

B: Changes maintaining full or upward compatibility

C: Changes limiting or excluding compatibility

	Name	Date	Signature
Approved	Sven Bremicker	18.09.01	<i>Bremicker</i>

IMPORTANT SAFETY INSTRUCTIONS

This manual contains important instructions that shall be followed during installation and maintenance of the Sunny Boy.

To reduce the risk of electrical shock, and to ensure the safe installation and operation of the Sunny Boy, the following safety symbols have been placed throughout this technical description to indicate dangerous conditions and important safety instructions.



WARNING: This indicates a fact or feature very important for the safety of the user and / or which can cause a serious hardware defect if not applied appropriately.

Use extreme caution when performing this task.



NOTE: This indicates a feature that is important either for optimal and comfortable usage or optimal operation of the system.

Follow instructions closely.



EXAMPLE: This indicates an example.

SAVE THESE INSTRUCTIONS

IMPORTANT SAFETY INSTRUCTIONS

- **All electrical installations shall be done in accordance with the local and national electrical codes ANSI/NFPA 70.**
- **The Sunny Boy contains no user serviceable parts. Please return the unit to an SMA authorized Service Center (see page 56) for maintenance.**
- **Before installing or using the Sunny Boy, please read all instructions and cautionary markings in the technical description and on the Sunny Boy and the PV-array.**
- **Connecting the Sunny Boy to the electrical utility grid must only be done after receiving prior approval from the utility company and performed only by qualified personnel.**
- **Completely cover the surface of all PV-arrays with opaque (dark) material before wiring them. PV arrays produce electrical energy when exposed to light and could create a hazardous condition.**
- **On top of the device you can find the heat sink of the Sunny Boy with potential temperatures of over 175°F (80 °C). To reduce the risk of burns, do not touch.**

SAVE THESE INSTRUCTIONS

Table of Contents

1	Introduction	6
2	Installation	7
2.1	What Must Be Done in Case of Transport Damages?	7
2.2	Placement of the Sunny Boy	8
2.3	Electric Connection.....	12
2.3.1	Preparation of the electric connection	14
2.3.2	Connection to Electrical Utility Grid	16
3	Commissioning.....	20
4	Operation and Failure Indication LEDs	24
4.1	Operation Indicator	27
4.2	Ground Fault Indicator	30
4.3	Failure Indication	31
4.4	Opening and closing of the Sunny Boy.....	36
4.5	Upgrading or modification of the Sunny Boy interface	39
4.6	Measuring Channels and Messages.....	41
4.7	Measurement Precision	43
5	Troubleshooting	44
6	Warranty Regulations and Liability	46
7	Technical Data	48
7.1.1	Minimum MPP-voltage of the PV panel.....	49
8	Appendix	56

1 Introduction

The SMA Sunny Boy is a string inverter for grid tied operation. With this manual the Sunny Boy can be installed and operated in a safe way. This installer's guide is used as reference for the commissioning and as guideline on how to use all functions of the inverter optimally and how you can extend your existing PV-plant.

Supplementary grid feeding includes the conversion of the DC-voltage from the PV-panel to grid compatible AC-voltage with so-called "inverters" and the subsequent connection to the electricity grid in the house distribution.

Here the electricity from the PV-modules provides all consumers with electric power (household devices, lights etc.). In case that not enough power is produced the additionally necessary power is obtained from the grid. In case that there is a surplus of power, this surplus is fed into the local grid and is therefore available for other consumers. This way every single kilowatt-hour is utilized and the electricity company's power systems are relieved. In the most simple case a PV-plant therefore consists of two basic components: the PV-panel and the inverter.

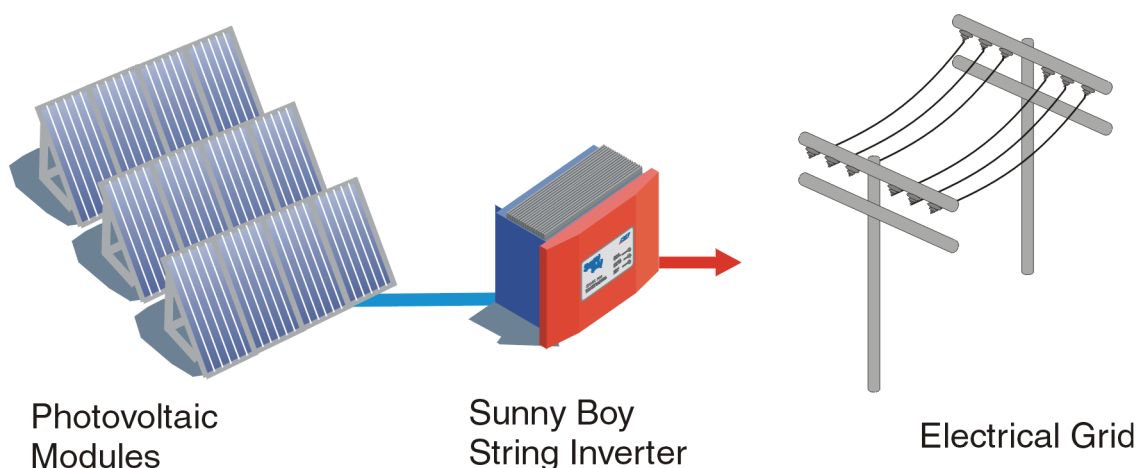

Fig. 1.1: Grid tied string inverter application

For a more detailed technical description of the Sunny Boy and its functionality please read "Sunny Boy 2500U Technical Description".

2 Installation



WARNING: Before installing the Sunny Boy, read all instructions and cautionary markings in the technical description and on the Sunny Boy and the photovoltaic array.



WARNING: All electrical installations shall be done in accordance with all local electrical codes and the National Electrical Code (NEC), ANSI/NFPA 70.



WARNING: Connecting the Sunny Boy to the electrical utility grid must only be done after receiving prior approval from the utility company and performed only by qualified personnel.

2.1 What Must Be Done in Case of Transport Damages?

The Sunny Boy inverters are thoroughly checked before they are shipped. Even though they are delivered in a sturdy packaging (which can be recycled) the inverters can be damaged which is the forwarding company's fault in most cases.

Please inspect your inverter thoroughly after it is delivered. If any damages can be detected on the packaging that could lead to the conclusion that the contents is damaged or if you detect that the inverter is damaged please immediately notify the forwarding company.

SMA or your local supplier can help you in this matter. In any case the declaration of transport damage must be made within 6 days upon receipt of the product and must be stated in writing directly to the forwarding agent. If it is necessary to return the inverter to the manufacturer please use the packaging the inverter was sent in.

2.2 Placement of the Sunny Boy

The Sunny Boy is a sophisticated electronic device and is therefore sensitive to humidity **within** the case.



NOTE: If the Sunny Boy is placed outside, the humidity during the installation should be as low as possible - pay special attention that it does not rain. If moisture is enclosed in the case it will eventually condense within the device which could damage the electronics.

A suitable position must be found for the inverter while the PV-plant is designed. In the following you will find a summary of the most important criteria.

Criteria for device mounting:

- Due to the high protection class (NEMA 4X) of the enclosure the installation is possible indoors as well as outdoors.
- If possible, do not expose the inverter to rain despite NEMA 4X.
- Keep the DC-cabling from the solar panel to the inverter as short as possible.
- Avoid installation in the living area because a slight noise emission is possible.
- Avoid mounting on resonant parts (e. g. thin wooden panels, plaster panels, etc.). The Sunny Boy tends to slightly vibrate when under load.
- Provide accessibility for installation and later service.
- Installation in eye-height allows to easily read the operating LEDs or the Sunny Display.



CAUTION: Please note the following points in any case:

- The mounting background must be firm.
- The ambient temperature must be between $-13\text{ }^{\circ}\text{F}$ and $+140\text{ }^{\circ}\text{F}$.
- The National Electrical Code (NEC) requires that the inverter be connected to a dedicated circuit and no other outlets or device may be connected to this circuit. See NEC Section 690-64(b)(1). The NEC also impose limitations on the size of the inverter and the manner in which it is connected to the utility grid. See NEC Section 690-64(b)(2).
- Do not expose the string inverter to direct sunlight (if necessary install a shading roof).
- A minimum distance of 8 inch (200 mm) must be clear above the inverter for ventilation, i. e. no cupboards, ceiling, etc.
- Free air circulation around the case must not be obstructed.
- If you are installing the Sunny Boy in a cabinet or closet etc., the air circulation must be sufficient for heat dissipation - provide external ventilation.
- The heat sink can reach a temperature of more than $175\text{ }^{\circ}\text{F}$.
- Check existing electrical installations or plumbing prior to drilling holes into the wall.
- Provide a correct position of the inverter - see below:

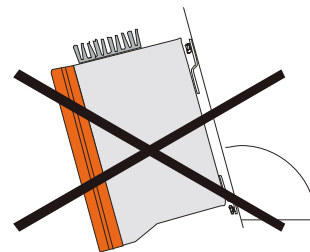
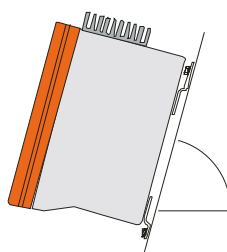
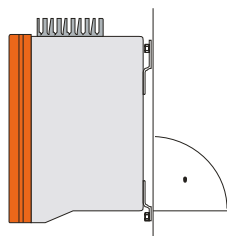

mount straight or tilted to the back

never mount tilted to front

Fig. 2.1: How to mount the Sunny Boy

The Sunny Boy inverter is mounted on the back side with the three metal straps.

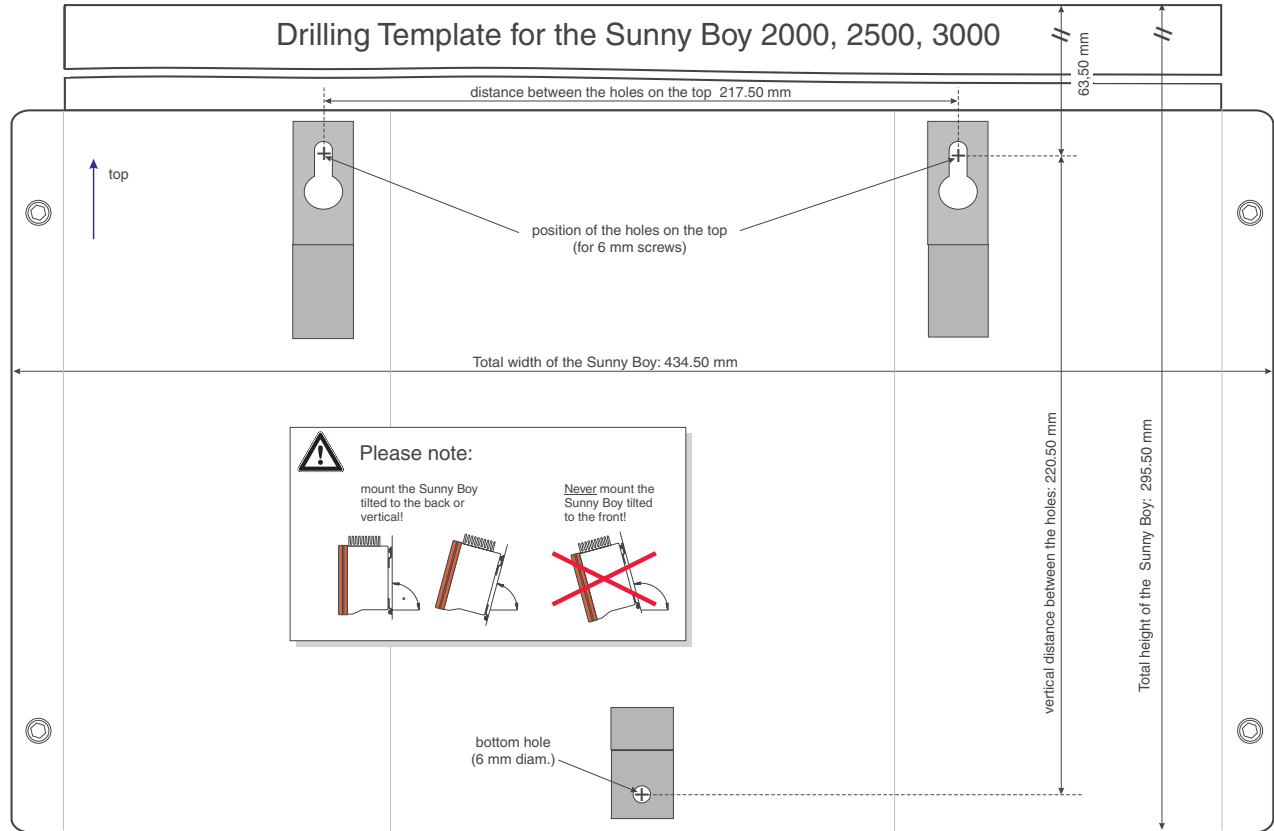

Fig. 2.2: Picture of drilling template - original template in appendix

Preparing the Mounting

The Sunny Boy is mounted on its back side with the 3 metal straps. For that 3 screws and 3 according dowels (wall anchors) are necessary. The screws and dowels are not included. We recommend 6 mm screws and 8 mm dowels.



NOTE: For outside mounting use stainless steel screws. Use a plastic washer in order to avoid scratching the paint.

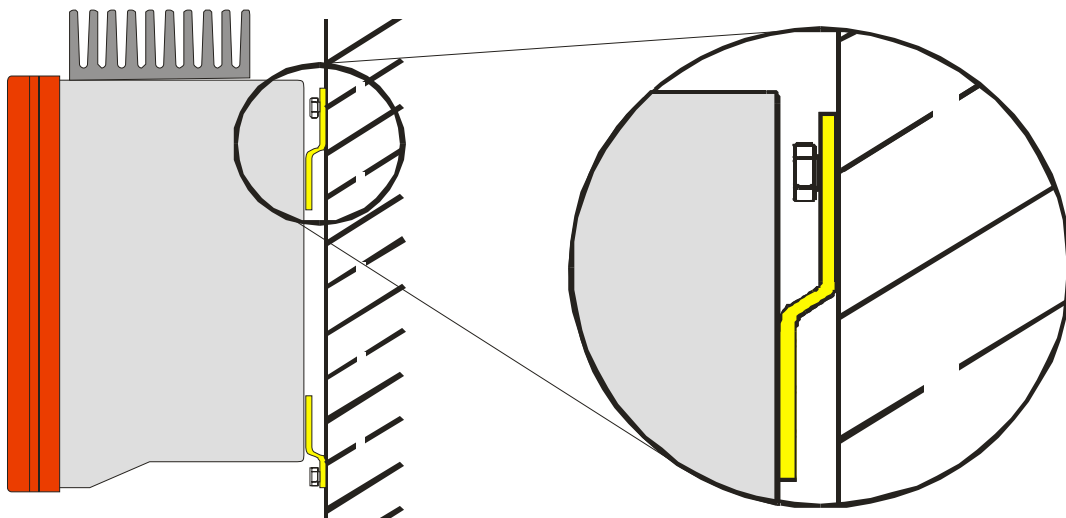

Fig. 2.3: Side view of the mounting to wall

Metal straps for mounting: The top straps take the load, the bottom is screwed down in order to prevent the tilting off the wall.

Mounting to wall

- Mark the holes with the drilling template.
- Drill the holes (and put in the wall anchors), put in the screws of *both top holes* and screw them in until ca. 4 mm are sticking out.
- Hang the inverter into the two top screws.
- Fasten the bottom screw. This will prevent lifting of the inverter case.
- Check the mounting of the inverter.

2.3 Electric Connection

The electric connection of the Sunny Boy can be done once the device is correctly mounted in its position.

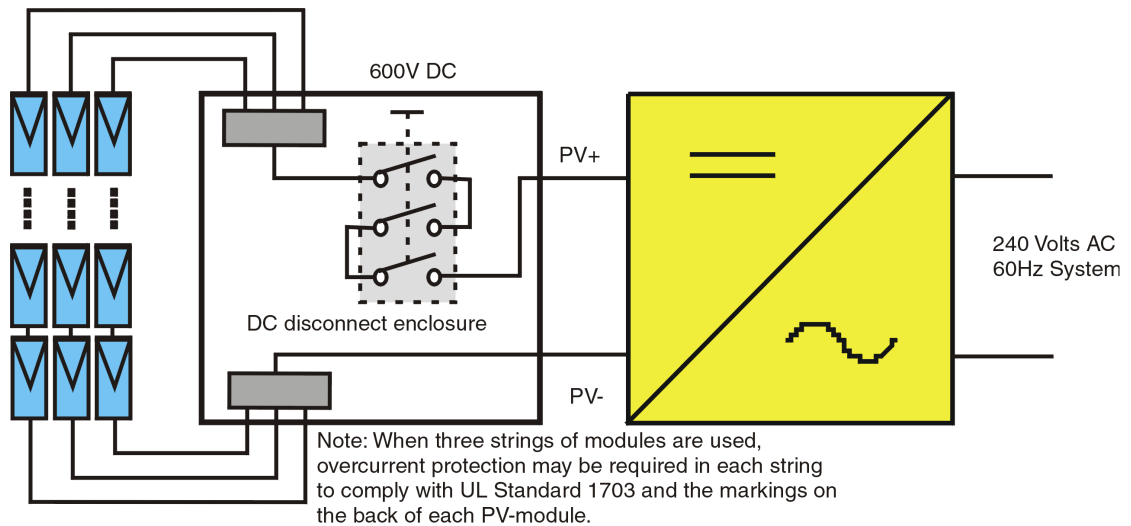

Fig. 2.4: Simplified electrical wiring diagram of the PV-system

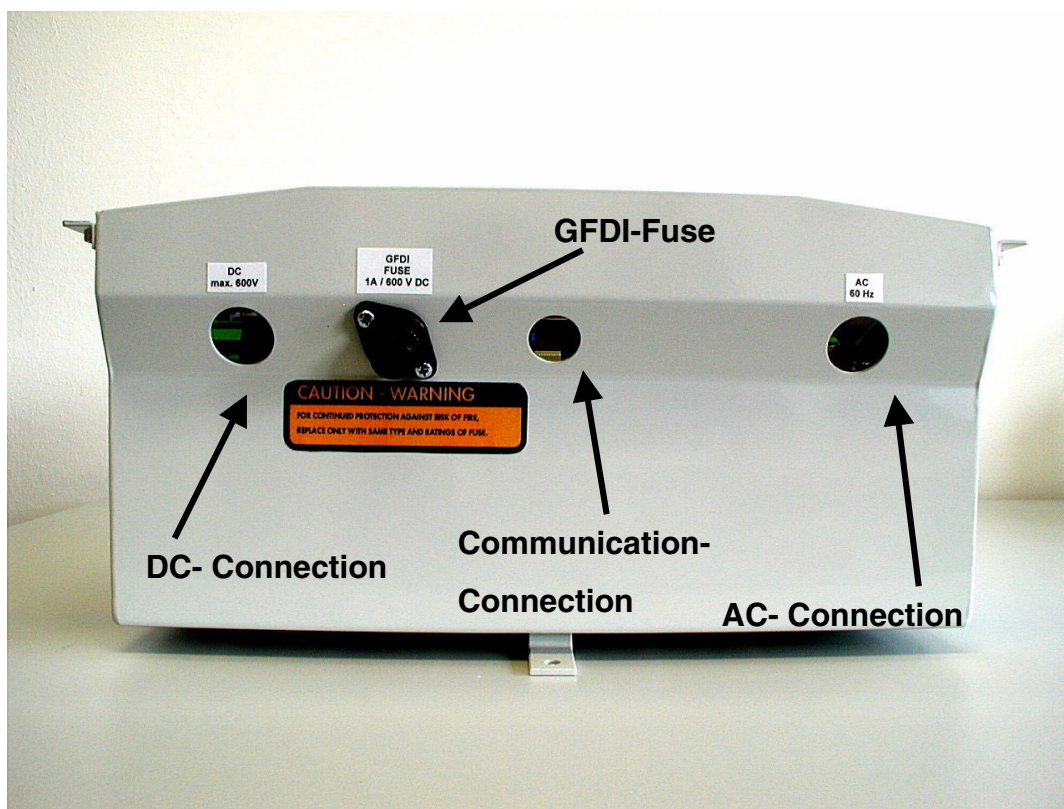

Fig. 2.5: Underside view of the Sunny Boy



WARNING: All electrical installations shall be done in accordance with all local electrical codes and the National Electrical Code (NEC), ANSI/NFPA 70. Use no. 14 AWG, minimum 90 °C (194 °F), copper wire for all connections with the Sunny Boy. Voltage drop and other considerations may dictate that larger wire sizes be used.

The AC-grid and the input from the DC disconnect enclosure are connected to the inverter inside the case. Cables with wire sizes up to 10 AWG (5.26 mm²) are accepted by the AC- and DC-terminals on the printed circuit board.



WARNING: The connection of the Sunny Boy to the DC-voltage from the PV string and the AC-voltage of the utility must be done in the order described here. This ensures that the disconnecting of contacts as well as hazardous voltages during the installation are avoided.

- Connect the Sunny Boy to the electricity grid
- Connect the PV strings to the DC disconnect enclosure
- Connect the DC disconnect enclosure to the Sunny Boy
- Connect the utility by switching all breakers ON

To disconnect the Sunny Boy from the system, first turn all breakers and switches OFF. Then disconnect the various conductors in the reverse order listed above.

2.3.1 Preparation of the electric connection

Remove all screws (1 - 4, size M5 (see Fig. 2.6)) and take off the lid. When removing these screws, be sure to save the special lock washers and reinstall them to properly ground the front panel.

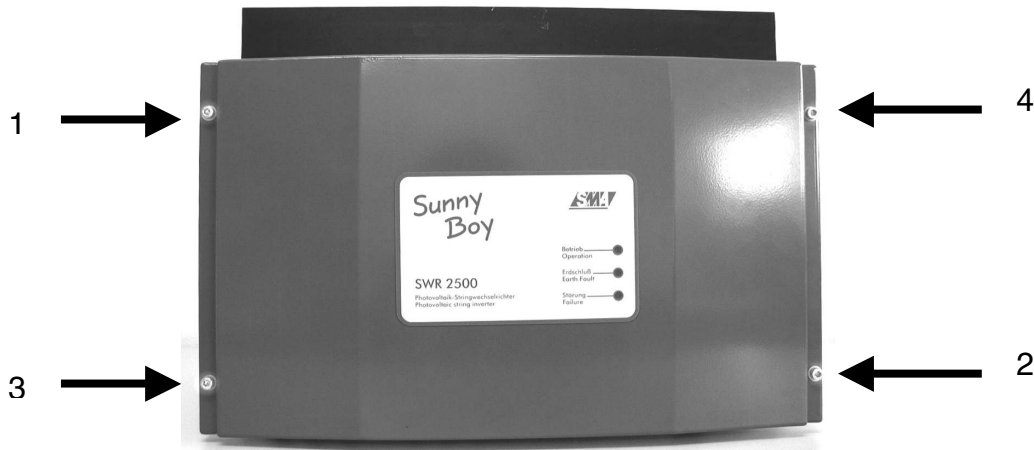

Fig. 2.6: Front view of the Sunny Boy 2500U

You now have the opened Sunny Boy in front of you (see Fig. 2.7) and can see the position of components and clamps relevant for you. You will find:

- The internal grid fuse



WARNING: A defective grid fuse has to be replaced only with same types and rating of fuse in order for continued protection against risk of fire. The type is Littelfuse 314015 15 AMP 250V AC.

- The control system board with the socket for the Piggy Back board for the communication
- Terminal for the AC-connection
- Terminals for the DC-connection

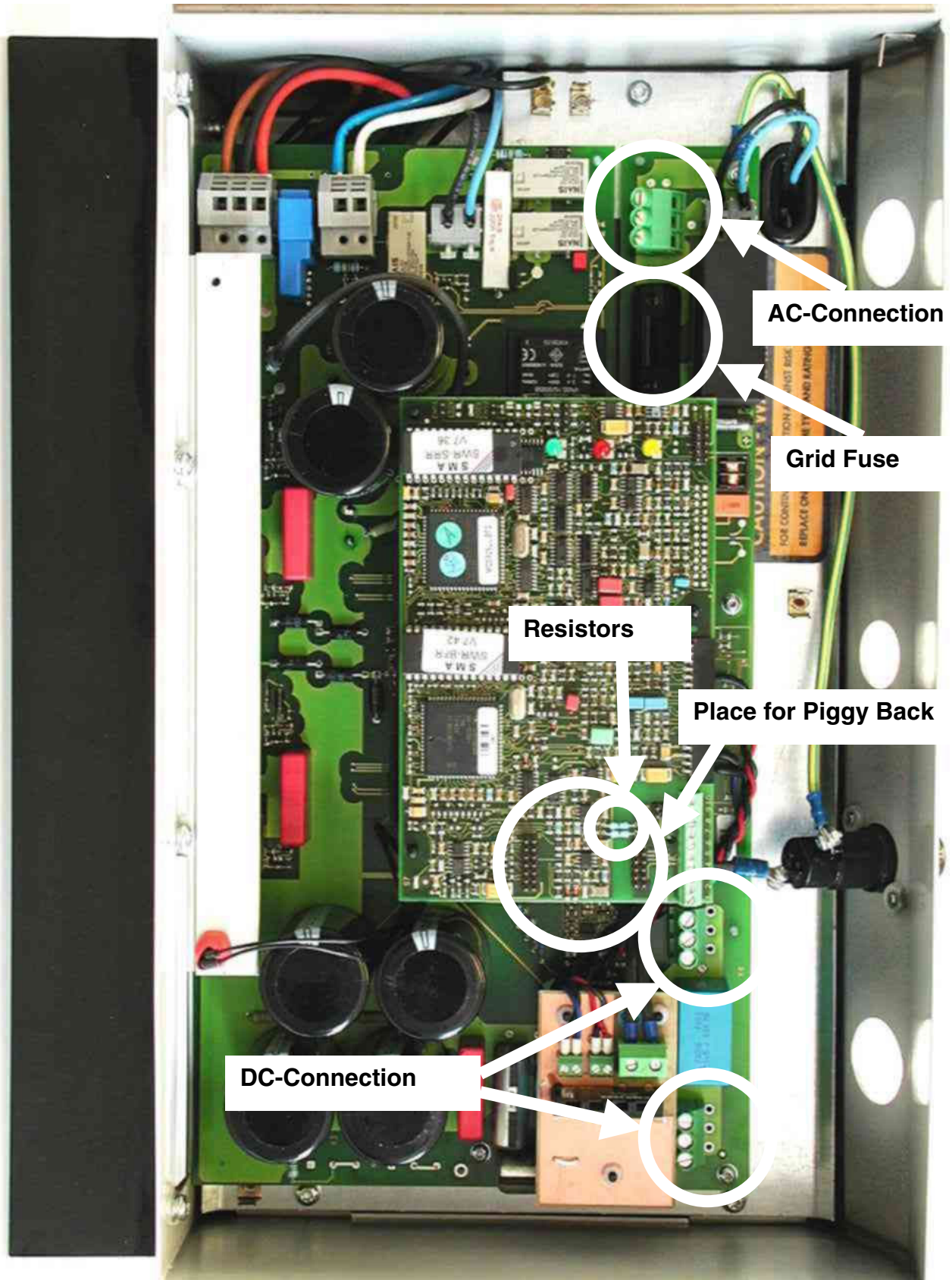

Fig. 2.7: Interior of the Sunny Boy 2500U

2.3.2 Connection to Electrical Utility Grid

The Sunny Boy must be connected to the grid with 3 cables

- with two phases (L1) and (L2) and one equipment-grounding conductor(Protective earth (PE)).



WARNING: Make sure the main 240 V breaker in the main utility breaker box is switched OFF before you connect the AC terminal block.

The grid impedance value at the connection point should be as low as possible to avoid an increase of the AC-voltage to non-permissible values while the Sunny Boy feeds to the grid. This also results in a higher system efficiency.



EXAMPLE: The impedance is the sum of the electricity grid impedance at house distribution and all impedance values of cables and clamping points.

NB: Impedance values are

- ca. 0.44 Ω for a 70 feet (16.4 m) cable with a cross section of AWG 14
- ca. 0.40 Ω for a 100 feet (33 m) cable with a cross section of AWG 12
- ca. 0.43 Ω for a 175 feet (57 m) cable with a cross section of AWG 10

The total impedance of the grid plus the interconnecting ac cables should be less than 1.25 Ohm.

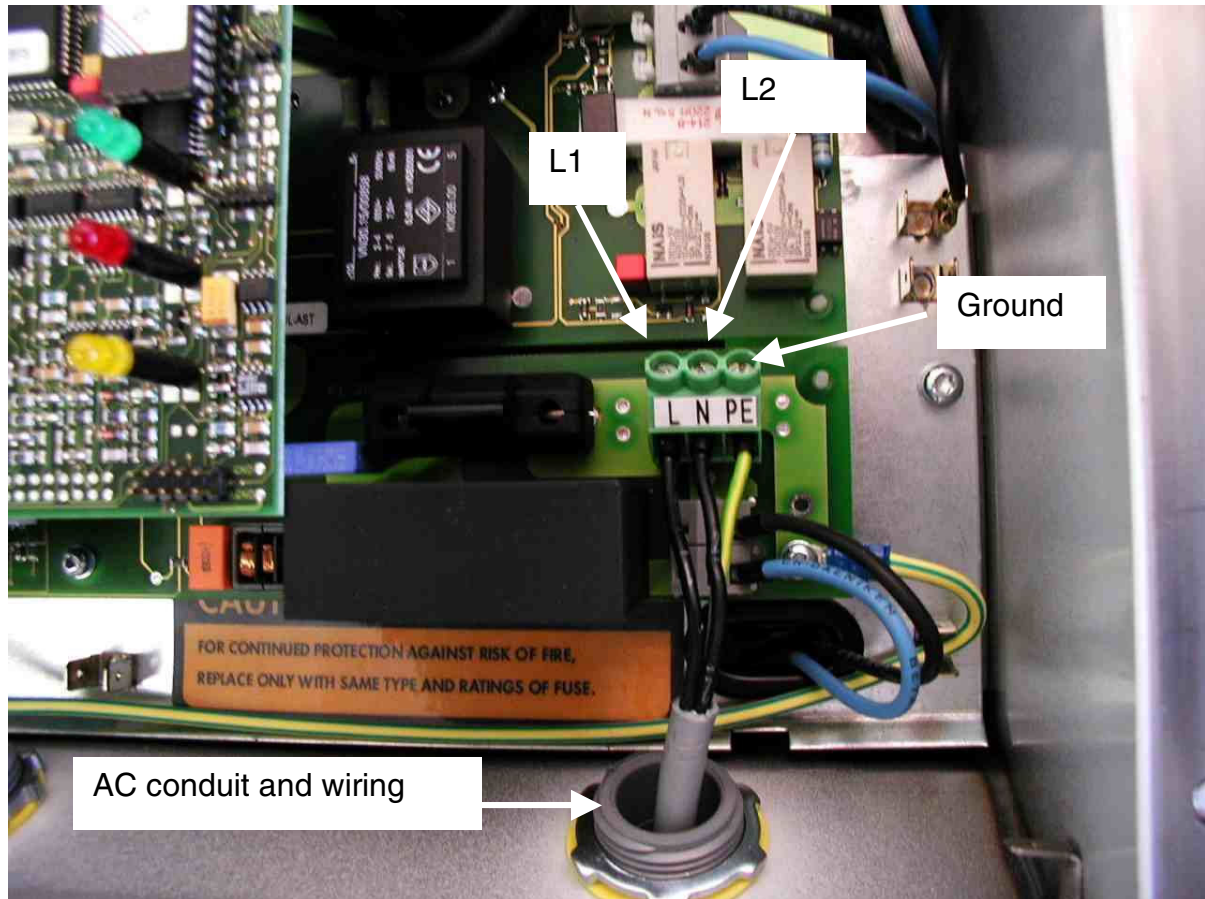

Fig. 2.8: AC connection socket

- Connect the main 240 Volt AC-breaker box to the Sunny Boy by a 1/2" conduit.
- Insert the conduit fitting in the very right opening of the Sunny Boy. Fasten the fitting on the inside of the Sunny Boy with the nut.
- Pull the wires through the conduit into the interior of the Sunny Boy.
- Connect the wire L1 to the terminal labeled L in the Sunny Boy (see Fig. 2.8).
- Connect the wire L2 to the terminal labeled N in the Sunny Boy.
- Connect the equipment-grounding conductor to the terminal labeled PE in the Sunny Boy.
- Torque wires with torque of 35 in-lb.
- Ensure all connections are correctly wired and properly torqued.

Connection of the PV-panels to the DC disconnect enclosure



WARNING: Completely cover the surface of all PV-arrays with opaque (dark) material before wiring them. PV-arrays produce electrical energy when exposed to light and could create a hazardous condition.

Depending on the type of PV-module used it is possible to connect one single string or several parallel strings. Therefore there are three connections for both the + and the - pole. Within the device these connections are connected in parallel each.



WARNING: Before connecting the connectors of the PV-panel to the DC disconnect enclosure check the correct polarity and admissible PV-panel voltage between the + and the - cable connectors of the PV-panel.

The PV-panel open circuit voltage must be below or at most equal to 600 V DC ($V_{pv} \leq 600 \text{ V DC}$) under all conditions. Please read chapter 7.1.1

Connection of the Sunny Boy to the DC disconnect enclosure

- Install the DC conduit from the DC disconnect enclosure to the Sunny Boy.
- Insert the conduit fitting in the very left opening of the Sunny Boy. Fasten the fitting on the inside of the Sunny Boy with the nut. Do the same at the DC disconnect enclosure .
- Ensure all circuit breakers in the DC disconnect enclosure are in the OFF-position.
- Route the wires from the DC disconnect enclosure through the conduit and into the Sunny Boy.
- Connect the positive (+) wire to the terminal block labeled with (+), see Fig. 2.9.
- Connect the negative(-) wire to the terminal block labeled with (-), see Fig. 2.9.
- Torque wires with torque of 35 in-lb .
- Ensure all connections are correctly wired and properly torqued.

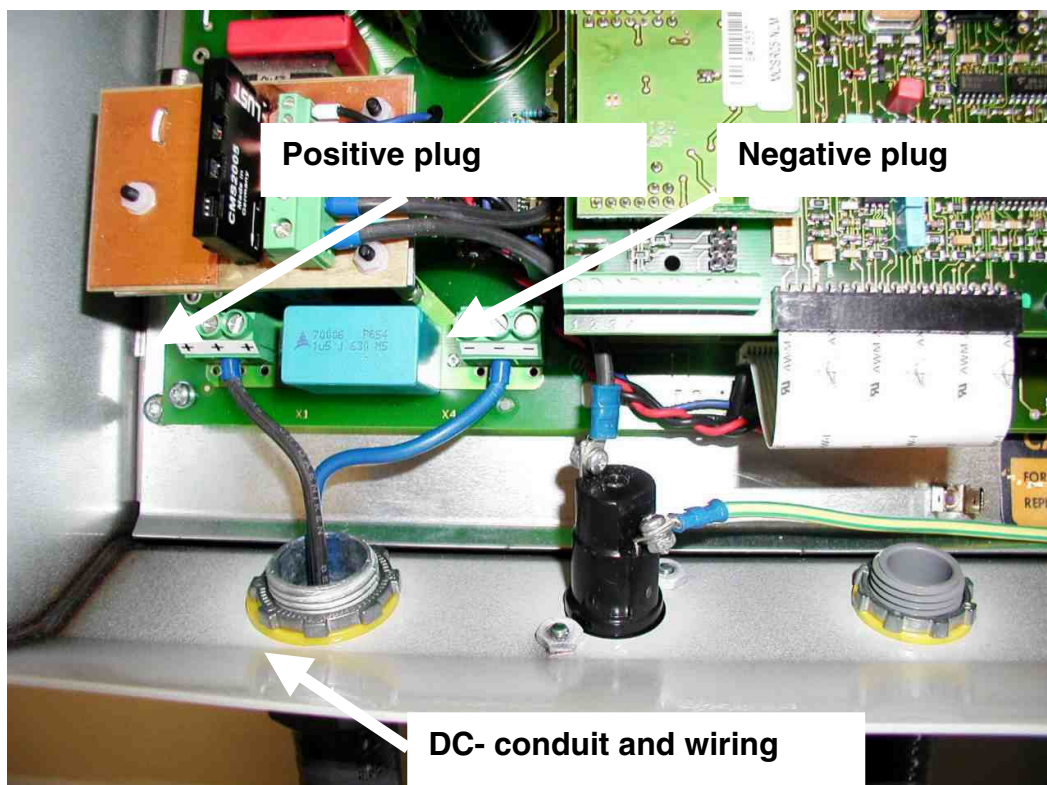

Fig. 2.9: DC connection socket

3 Commissioning

Safety Notice



NOTE: Make sure that nothing is on top of the heat sink of the Sunny Boy when it is running.



WARNING: The heat sink can get very hot - i. e. over 175 °F (80 °C).



NOTE: Make sure that all fittings are sealed and all openings on the bottom are closed with the seals.

- When putting the lid on make sure the seal in the inner side of the lid is placed correctly. When screwing the inner screws make sure that the thread in the Sunny Boy case is not damaged by tilted screws. Under certain conditions the enclosure type NEMA 4X cannot be guaranteed any more. When mounting the Sunny Boy outside moisture can get into the device and damage the electronics.



WARNING: Make sure that the lid is closed before applying power to the Sunny Boy.

- Ensure that all AC and DC wiring is correct.

First switching on

Please follow the order described when commissioning the device.

Fig. 3.1: Diagram of commissioning” provides a sequence chart for commissioning.



NOTE: Following this procedure you will make sure that the PV-panel is isolated from earth and the GFDI-fuse is not defective without using any additional measuring instrument.

- Remove the GFDI-fuse from the Sunny Boy (see Fig. 2.5).
- Connect the grid voltage by switching ON the main 240 V AC-circuit breaker of the supply lead.
- Uncover the PV-panel. At sufficient insolation the PV-panel produces the required output power for supplying the Sunny Boy.
- Switch ON the DC-circuit breaker in the DC disconnect enclosure . Now the Sunny Boy is supplied with the DC-voltage and starts to operate.
- If the PV-panel is isolated from earth first the yellow and red LEDs and after approx. 20 seconds only the red LED is on at the Sunny Boy. If you have communication equipment you will be displayed the “GFDI-Fuse open” failure. Should *both* the red *and* the yellow LEDs still be on there is a ground fault of the PV-panel. If you have communication equipment you will be displayed the “EarthCurrentMax” failure. The ground fault has to be removed. Then the commissioning procedure described above has to be repeated until only the red LED is on.
- When you have made sure the PV-panel is isolated from earth (only red LED on) switch the DC-breaker OFF.
- Wait until the LEDs at the device have turned off (max. 5 minutes).
- Screw the GFDI-fuse into the fuse holder at the Sunny Boy again.
- Switch the DC-breaker ON again so that the Sunny Boy is supplied with the DC-voltage.

- The Sunny Boy switches to fully automatic normal operation. The green LED is blinking. Should the red LED still be on the GFDI-fuse is defective and has to be replaced. (You will find a description of the correct type in chapter 4.2.)

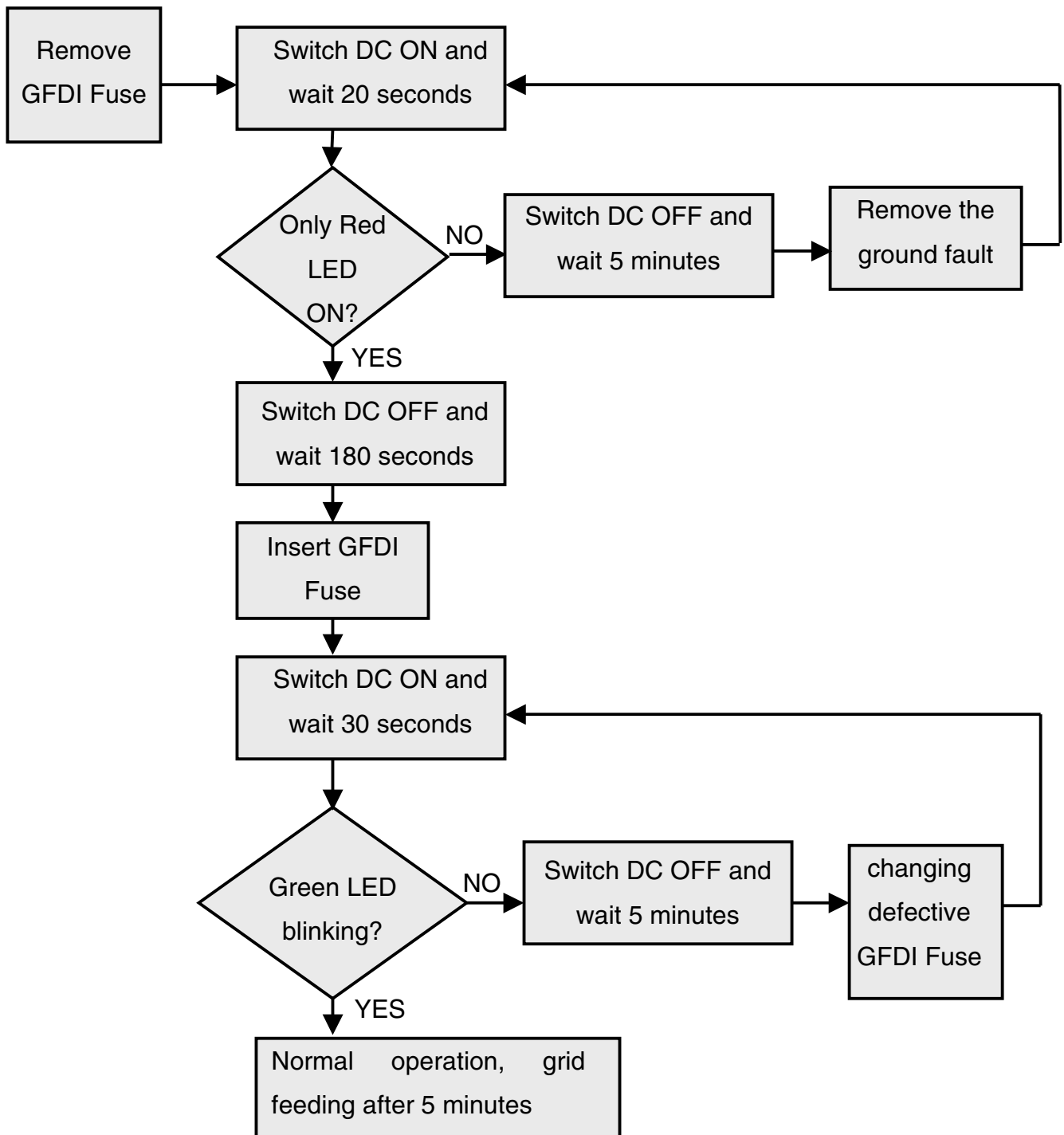

Fig. 3.1: Diagram of commissioning

If the input voltage is high enough the Sunny Boy should start to feed inverted PV-power fully automatically to the grid, once enough power is coming from the PV-modules.

The design of the Sunny Boy makes sure that its internal consumption is as low as possible. The Sunny Boy requires a maximum 7 W internal consumption which it takes from the PV-panel.

If you measure the voltage of the PV-modules you must keep in mind the inverter's internal consumption that will have an effect on your measurement with lower solar radiation. The open circuit voltage of the PV-panel will therefore not be displayed. The internal consumption is negligible for the voltage measurement with higher solar radiation.

The operating state of the Sunny Boy will be indicated with three LEDs integrated into the lid. The meaning of the LEDs will be explained in chapter 4, "Operation and Failure Indication LEDs".

4 Operation and Failure Indication LEDs

The inverter normally operates automatically, without user interaction and without any maintenance. The inverter automatically turns itself off when a grid feeding is not possible (e. g. at night).

The Sunny Boy automatically starts its grid feeding the next day once the solar radiation is high enough. The inverter goes to standby mode if the radiation and the resulting electric input energy is too low and is therefore always ready for operation.

Each time the Sunny Boy starts up it runs a number of self test and safety procedures which the user does not notice.

The user can obtain the inverter's operating status from the 3 integrated LEDs on the lid (see Table 4.1: Operation indication overview).

The **green** LED "Operation" describes the current operation of the Sunny Boy, see chapter 4.1 "Operation Indicator".

The **red** LED warns the user that the GFDI-fuse is defective. A description of this situation and what has to be done in that case is given in chapter 4.2.

The **yellow** LED "Failure" indicates an internal or external failure that keeps the inverter from feeding the grid. The specific causes for this and how to avoid them are described in chapter 4.3 "Failure Indication".

The **red and yellow** LED combined indicate that the internal Ground Fault Detector and Interrupter (GFDI) has detected a ground fault in the PV panel. A description of this situation and what has to be done in that case is given in chapter 4.2.



Fig. 4.1: Front view of Sunny Boy 2500U

Description of the symbols used in the following section:

- ⊗ LED off
- ◐ LED on once per second
- ⊗ LED on three times per second
- ◑ LED on with short interruptions (75% on, 25% off)
- LED on
- Not important









LED indicator		Operating condition	Description
green: red: yellow:		standby (night)	input voltage < 120 V
green: red: yellow:		initialization	input voltage: 120 V ... 240 V
green: red: yellow:		stop	changing operating condition or manually initiated condition
green: red: yellow:		waiting, checking grid	starting conditions are being checked
green: red: yellow:		feeding grid MPP or constant voltage mode	normal operation
green: red: yellow:		derating mode	Reduction of power fed to the grid due to increased temperature of the heat sink
green: red: yellow:		insulation failure	ground fault of the PV-panels see chapter 4.2
green: red: yellow:		failure	GFDI fuse is defective see chapter 4.2
green: red: yellow:		failure	internal or external failure, exact description depending on blink code see chapter 4.3
green: red: yellow:		Consistent Failure	A failure of the utility has occurred

Table 4.1: Operation indication overview

4.1 Operation Indicator

Standby (night)

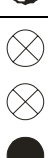

all LEDs are off



The Sunny Boy is in “Standby” mode. The input voltage is too low ($V_{PV} < 120 \text{ V}$) for supplying the Sunny Boy control system with enough power.

Initialization



all LEDs are on





The Sunny Boy control system is initializing.

The string voltage to the inverter is between approx. 120 V and 240 V. The supply is sufficient for the system control and not quite sufficient for feeding to the grid. Data transmission is not possible.



NOTE: In some seldom cases (bad weather, low solar radiation) the LEDs can go on all at once and off again. This “blinking” results from the fact that the incoming radiation is not high enough for the Sunny Boy to keep it stable. Note: This is not a malfunction!



Stop

-  Green LED blinks (3 times per second)
-  Red LED off
-  Yellow LED off

The inverter has stopped operation, among other tasks the measurement electronics is calibrated. Subsequent condition is "Waiting".

"Stop" condition can be initiated by the user with the Sunny Boy Control or the program Sunny Data. The Sunny Boy remains in this condition until set to "MPP-Operation" or "Constant Voltage Operation".

Waiting, Grid Monitoring

-  Green LED blinks (once per second)
-  Red LED off
-  Yellow LED off

The Sunny Boy is checking the utility concerning its suitability for feeding electricity (starting voltage, starting time) and begins to monitoring.



NOTE: If the Sunny Boy fails to connect to the utility 3 times in a row, it will wait for 10 minutes before the next attempt.

Operation

- Green LED on
- ⊗ Red LED off
- ⊗ Yellow LED off all LEDs are off

The Sunny Boy is feeding the local electricity grid, either in "MPP" or in „Constant - Voltage“ operation.

- **„MPP“-operation (default setting):**

The Sunny Boy pushes the voltage from the PV-modules to the voltage with the maximum output power.

- **„Constant Voltage“-operation**

The voltage from the PV-modules can be set to a fixed value. This value is transmitted to the Sunny Boy with the Sunny Boy Control or with the Sunny Data software (The parameter is "V-Konst").

Derating

- ◐ Green LED blinks (75 % ON, 25 % OFF)
- ⊗ Red LED off
- ⊗ Yellow LED off

The Sunny Boy is feeding the local electricity grid, either in "MPP" or in „Constant - Voltage“ operation. Additionally it is in the derating mode due to increased temperature of the heat sink.

4.2 Ground Fault Indicator

Isolation failure

-  Green LED off
-  Red LED on
-  Yellow LED on

This is the result of a ground fault of the PV panel. The inverter then has to indicate this condition and disconnect from the grid. The inverter has to be reset manually, it cannot restart automatically.



CAUTION: The PV-array must be inspected for ground faults.

Please have a look at chapter 3 “First switching on”.

If the ground fault of the PV panel is removed, the inverter switches from “permanent device disable” to “GFDI Fuse open” failure and the yellow LED is off.

The red LED is still on. Now the following must be done:

Defective GFDI fuse

-  Green LED off
-  Red LED on
-  Yellow LED off

The failure “GFDI Fuse open” is displayed. If an intact fuse is then installed, the inverter restarts operation. The “GFDI Fuse open” failure persists in case the fuse is defective.



WARNING: For continued protection against risk of fire replace only with same types and rating of fuse. The type is Littelfuse KLKD 1 AMP 600 V AC / DC.

4.3 Failure Indication

Consistent Failure

Operation — 

Earth Fault — 

Failure — 

The yellow failure LED is permanently on.

This is a failure of the utility monitoring or the automatic disconnection device MSD. The Sunny Boy has detected a failure in the disconnection device and has suppressed the utility interaction on startup. The Sunny Boy must be checked by service personnel and can only be put back to operation after a thorough checkup.

Blinking code 2: Grid Failure

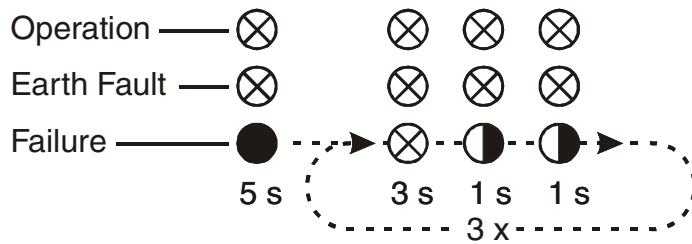

The yellow failure indication LED is on for 5 seconds, is out for 3 seconds and then blinks twice. The code is sent three times.

If the failure persists the indication blinking code is repeated.

The Sunny Boy is indicating a failure which has one of the following reasons:

- Low grid voltage ($< V_{AC\ min}$ see table 9.2)
- High grid voltage ($> V_{AC\ max}$ see table 9.2)
- Low grid frequency ($< f_{AC\ min}$ see table 9.2)
- High grid frequency ($> f_{AC\ max}$ see table 9.2)
- Drastic grid frequency change

Check the utility (check the function of other electric consumers) and check the fuse of the mains connector to the Sunny Boy.



NOTE: Have the grid connection to the Sunny Boy checked by a qualified electrician. Check the correct connection and the fuse in the Sunny Boy.



WARNING: Do not forget to disconnect the Sunny Boy from the grid. Before opening the device read chapter 4.4.

Blinking Code 3: Grid impedance too high (if the optional Grid Impedance Measurement is active)

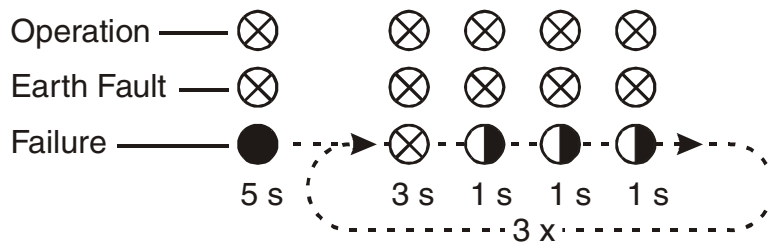

The yellow failure LED is activated for 5 seconds, remains dark for 3 seconds and then blinks three times. The code is sent three times.

If the failure persists the indication begins once again.

The Sunny Boy has detected a failure based on the utility impedance values. The criteria for the grid impedance is described in the section "Islanding protection" in the technical description of the Sunny Boy.

A too high utility impedance can be the reason should this failure occur very often. The impedance can be checked with the Sunny Boy Control or Sunny Data. This failure can normally be avoided by increasing the cross section of the AC-cabling.

Blinking code 4: Input voltage (PV-panel) too high

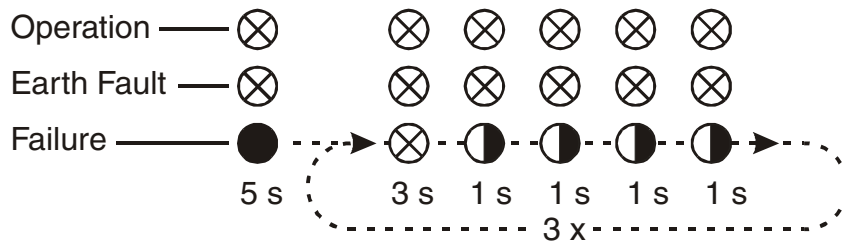

The yellow failure indication LED is activated for 5 seconds, is out for 3 seconds and then blinks four times. The code is sent three times.

If the failure persists the indication is repeated.

The input voltage is too high. **The PV-panels are generating a voltage higher than the permissible specified voltage!**



WARNING: Disconnect the PV-Panels from the Sunny Boy immediately.
Too high input voltage can destroy the Sunny Boy.

Have the circuits of your PV-panels checked.

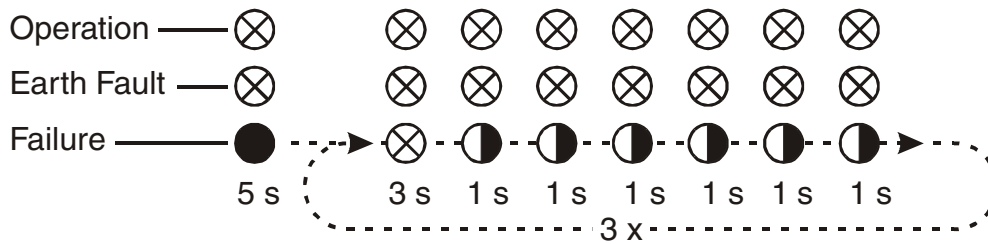
Blinking code 5: Device failure

The yellow failure indication LED is activated for 5 seconds, is out for 3 seconds and then blinks five times. The code is sent three times.

If the failure persists the indication is repeated.

The Sunny Boy is in a condition that makes it impossible to return to normal operation and is most likely defective.



NOTE: The Sunny Boy has to be checked by a qualified technician.

4.4 Opening and closing of the Sunny Boy

Normally the Sunny Boy operates fully automatically and maintenance-free. Should the device nonetheless be opened e.g. for

- upgrading or modification of the Sunny Boy interface
- control of internal AC-fuse

follow the instructions given below.

Opening of the Sunny Boy



WARNING: These servicing instructions are for use by qualified personnel only. To reduce the risk of electric shock, do not perform any servicing other than specified in this technical description unless you are qualified to do so.

When working on the Sunny Boy follow the instructions below:

1. Separate the Sunny Boy from the grid by opening the 240 Volt AC-circuit breaker in the main fusebox.



WARNING: Make sure the main 240V breaker in the main utility breaker box is switched OFF.

2. Switch the DC-breaker in the DC disconnect enclosure OFF.



WARNING: Wait for approx. 5 minutes until internal voltage has discharged after shutting down the DC-voltage on the Sunny Boy.

3. Take off the lid by removing screws 1 - 4 (see Fig. 2.6) on the lid (M5).

You now have the opened Sunny Boy in front of you (see Fig. 2.7) and can see the position of components and clamps relevant for you. You will find:

- The internal grid fuse



WARNING: For continued protection against risk of fire replace only with same types and rating of fuse. The type is Littelfuse 314015 15AMP 250 V AC.

- The control system board with the socket for the piggy back board for the communication. To install the new communication components read chapter 4.5.

Closing of the Sunny Boy

- When putting the lid on make sure the seal in the inner side of the lid is placed correctly. When screwing the inner screws make sure that the thread in the Sunny Boy case is not damaged by tilted screws. Under certain conditions the enclosure type NEMA 4X cannot be guaranteed any more. When mounting the Sunny Boy outside moisture can get into the device and damage the electronics.



WARNING: Make sure that the lid of the Sunny Boy is screwed tightly to the case before you start operating the Sunny Boy.

- Connect the PV-panel by switching ON the DC-breaker in the DC disconnect enclosure.
- Connect the grid by switching ON the main 240 Volt breaker.

With sufficient power from the PV-panel the Sunny Boy should now start automatically feeding the grid.

4.5 Upgrading or modification of the Sunny Boy interface

The Sunny Boy is prepared for data transmission. By simply plugging on a piggy back module it supports transmission via Powerline, RS232 or RS485 interfaces.

In order to install a new interface in the Sunny Boy a corresponding piggy back module has to be installed on the system control board.



WARNING: Follow all relevant instructions in chapters 2.3, “Electric Connection”, 3, “Commissioning”, 4.4, “Opening and closing of the Sunny Boy” in the Sunny Boy manual.



WARNING: The Sunny Boy works with high voltages externally and internally which can cause considerable harm to people. Only a qualified electrician may work on the device, especially open it!

While upgrading the Sunny Boy interface the operator can get into touch both with electronic components and components carrying lethal voltage. Faulty upgrading can lead to damage at the device and danger to people by electric voltage.

Therefore the device may only be upgraded by qualified personnel or the SMA service.



WARNING: Only work on the Sunny Boy when it is disconnected from the grid and is sufficiently discharged!

Follow ESD protection countermeasures when modifying the Sunny Boy:

Electronic components are sensitive to electrostatic discharge. To protect them you have to be on the same electric potential. Discharge the electrostatic charge by touching the grounded case before touching an electronic component, otherwise you run a great risk in destroying your electronics.

Open the device as described in chapter 4.4.

Remove the piggy back that is installed on the system control board.

- **Only for installation of an RS232 or RS485 board:**
 - Remove the light blue resistors (see Fig. 2.7) on the system control board by cutting them out with a wire cutter.
- **Only for installation of a board for Powerline Communication:**
 - Please make sure that the light blue resistors (see Fig. 2.7) are plugged onto the system control board. If not, wires (corresponding to 0 Ohm resistors) have to be soldered in there. Plug the desired piggy back module onto the required slot. When plugging on the piggy back please make sure no socket of the piggy back plug-in contacts remains open.

Connect the cables for RS232 or RS485. No cabling is necessary for Powerline communication. Data cables are lead outside through the free opening at the bottom of the Sunny Boy. Please insert the PG16 screws into this opening and fasten them.

- Push the communication cable through the contact unit of the PG cable fitting.
- Connect the terminal cables to the terminal strip of the system control board and check whether they are firmly fastened.
- Fasten the cable seal of the PG16 cable fitting.
- If you have installed RS232 cabling please close the opening in the bottom with the seal included in the packing list.
- Close the device as described in chapter 4.4.

4.6 Measuring Channels and Messages

The communication supports a number of measuring channels and messages from the Sunny Boy inverters.

The following abbreviations are used:

BFR	B etriebsföhrungsrechner (Sequential Control System)
SRR	S tromregelungsrechner (Current Control System)

Measuring Channels

Vpv	PV-input voltage
Vpv-Setpoint	PV-desired input voltage of the Vpv-control
Iac	current to the grid
Vac	grid voltage
Fac	grid frequency
Pac	power fed to grid
Zac	grid impedance
Vpv- _{PE}	PV-voltage to earth
Ipv	current from PV-panels
E-Total	energy yield
h-Total	total operation hours
Power On	total system start ups
Serial Number	<i>Sunny Boy</i> serial number
Mode	operating mode
Error	failure description for mode "disturbance"

Mode Messages

Stop	manual system stop
Offset	offset calibration of the electronics
Waiting	grid switching-on conditions are not fulfilled (yet)
Grid monitoring	checking grid (grid impedance)
MPP-Search	PV voltage is determined and set
MPP	<i>Sunny Boy</i> is in MPP mode

V-Const	<i>Sunny Boy</i> is in constant voltage MPP mode
Derating	reduction of the grid feeding power
Disturbance	failure

Error messages

F-Bfr-Srr	communication between micro-controllers is failing
F-EEPROM	EEPROM cannot be read or written on
F-EEPROM dBh	EEPROM cannot be read or written on
F-Fac-Bfr	BFR-frequency measurement - value out of tolerable range
F-Fac-Srr	SSR-frequency measurement - value out of tolerable range
F-dZac-Bfr	BFR-impedance measurement - value out of tolerable range
F-dZac-Srr	SSR-impedance measurement - value out of tolerable range
F-lmax	internal over current
F-Shut-Down	internal over current continuous
F-MSD-UAC	different values between BFR and SRR for grid voltage
F-MSD-FAC	different values between BFR and SRR for grid frequency
F-MSD-Meas	different values between BFR and SRR for dl, Fac, Vac or Zac
F-K1-Close	Relay test failed
F-K1-Open	Relay test failed
F-EarthCurMax-S	SRR-earth current between PV- and GND is out of tolerable range
F-EarthCurMax-B	BFR-earth current between PV- and GND is out of tolerable range
F-MSD-ZAC	different values between BFR and SRR for grid impedance
F-Offset	Offset check for grid voltage failed
F-MSD-Timeout	BFR or SSR controller failure
F-Vac-Bfr	BFR-grid voltage measurement - value out of tolerable range
F-Vac-Srr	SSR-grid voltage measurement - value out of tolerable range
F-VpvMax	PV input voltage out of tolerable range
F-Zac-Bfr	BFR-grid impedance measurement - value out of tolerable range
F-Zac-Srr	SSR-grid impedance measurement - value out of tolerable range
F-Watchdog	Watchdog for operation control triggered
F-GFDI Fuse Ope	The GFDI-Fuse is defective
F-ROM	Failure of Read only memory test

4.7 Measurement Precision

Any kind of measurement always depends on the accuracy. The reproducibility of the measurement values is conceived for an ambient temperature of 77 °F (25 °C). Other temperatures must be evaluated with respect to the inaccuracy resulting from these different temperatures.

	[Unit]	Range	Resolution		Maximal failure $\vartheta_0=+77\text{ °F}$
			Display	Measurement	
input voltage	U_{PV} [V]	0...650 V	1 V	1,12 V	± 2 %
input current	I_{PV} [mA]	0...12000 mA	1 mA	12 mA	± 4 %
grid voltage	U_{AC} [V]	180...300 V	1 V	0,3 V	± 1 %
grid current	I_{AC} [mA]	0...15000 mA	1 mA	30 mA	± 2 %
grid frequency	f_{AC} [Hz]	45...55 Hz	0,01 Hz	0,01 Hz	± 0,1 %
output power	P_{AC} [W]	0...2500 W	1 W	1 W	± 3 %
energy yield	E [kWh]	0...4,29* 10 ⁹ Wmin	1 Wmin	20 Wmin	± 3 %
operating hours	h [h]	0...4,29*10 ⁹ s	1 s	0,67 μs	± 0,1 %

Table 4.1: Measurement accuracy of the *Sunny Boy*

5 Troubleshooting

Our quality management strategy includes a constant quality improvement of our products. We always are concerned to avoid all failures and malfunctions of our products.

The product you purchased was shipped after successfully passing numerous tests concerning the operation behavior and the disconnection devices as well as long term heavy duty tests.

We recommend to conduct the following steps in case your PV-plant does not operate correctly:

- check the connection to the grid and to the PV-panels - pay attention to all safety measures listed in chapter 2 "Installation".
- check the blinking code on the lid of the Sunny Boy and compare the code with the blinking codes in chapter 4. Follow the countermeasures listed there, if necessary contact the installer.
- check the "Mode" and "Error" messages in the monitoring system if present.
- contact the Sunny Boy service if the system malfunction persists. The address is listed in the appendix.

In order to let your PV-plant operate again as soon as possible it is essential to provide the following information:

Information concerning the Sunny Boy

- serial number of the inverter
- Sunny Boy type
- short failure description
 - number of the blinking code (chapter 4)
 - if Sunny Boy Control or a PC with Sunny Data is present: What failure is indicated?
 - Can you reproduce the failure? How can you reproduce it?
 - Has this failure always occurred?
 - What were the ambient conditions as the failure occurred?

Information concerning the PV-modules

- Supplier, type of modules
- number of modules in string
- output power
- open circuit voltage

Use the original box the Sunny Boy was delivered in if it is necessary to send the Sunny Boy to the manufacturer.

6 Warranty Regulations and Liability

Warranty

The warranty period is **24 months** from the date of purchasing the device by the end user. It ends at the latest 30 months after the delivery date from SMA, and includes all defects caused by material or manufacturing faults.

The guaranty period for warranty repairs or compensation deliveries ends 12 months after delivery, but runs at least until the expiration of the original warranty period for the delivered item.

Evidence

SMA will only render warranty services if the rejected device is sent back to SMA together with a copy of the account the distributor has issued for the consumer. The type plate at the device must be legible. In case of non-fulfillment SMA reserves the right to refuse warranty services.

Conditions

The device will be repaired at SMA's discretion in its works without invoicing material and work, or a replacement resp. compensation device will be delivered.

The rejected device is to be sent back to SMA in the original packing, or in a transport packing of equal quality.

The customer has to grant SMA the necessary time and opportunity to repair the defects.

Exclusion of Liability

Excluded are any warranty claims and liabilities for direct or consequential damages due to

- transportation damages,
- improper installation or commissioning,
- improper alterations, modification or repairing attempts,
- inappropriate use or operation,
- insufficient air supply to the device,
- any installation and operation beyond the scope covered by according relevant safety regulations (VDE, UL1741, NEC, etc.),
- or force majeure (lightning, surge voltage, storm, fire).



NOTE: We cannot guarantee the proper function of the data transmission via mains lead (Powerline modem) in case it is carried out in electric grids with high harmonic distortion resp. high-frequency line distortions like e. g. industrial power supply grids, or in the neighborhood of irregular consumers (unshielded motors, switching power supplies, converters, etc.). Furthermore, the simultaneous operation of babyphones may lead to short-time data transmission disturbances or interruptions. In case of disturbed data transmission via mains lead, we offer alternatively a communication via separate data line as option (RS232 or RS485).

We do not guarantee that the software is completely free of failures. In case of a fault, an instruction how to avoid the effects of the fault is also considered as sufficient repair. Only the customer is responsible for the correct selection, orderly use, supervision, and the results of the use of software.

We reserve the right to make alterations serving the improvement of the device. Further or other claims for direct or indirect damages, especially including claims for damages from positive contract violation, are excluded insofar as not otherwise compelling stated by law.

7 Technical Data

Input (PV panel)

Maximum open circuit voltage of the PV panel



WARNING: It is essential to comply with the respective input voltage range which varies depending on the type and number of PV modules used.



WARNING: The maximum open circuit voltage of the PV panel may not exceed the specified maximum input voltage of the Sunny Boy.

The open circuit voltage of the PV panel depends on the temperature of its cells and on the respective solar radiation. The highest open circuit voltage of the PV panel occurs when the temperature of the cells is at its lowest point. Therefore it has to take into account the lowest possible ambient temperature of the PV panel when planning the PV plant. Based on this temperature and knowing the type of PV modules used you can then determine the maximum open circuit voltage of the PV panel. You can enter these data into our EXCEL[®] tool "GenAu" and check whether the maximum admissible input voltage of the Sunny Boy is not exceeded under any possible operating conditions. You will find this tool in the Internet for download at:

<http://www.SMA.de/ftp/energietechnik/sunnyboy/GenAu/GenAu.exe>



WARNING: The MPP-voltage of the connected PV-modules may not fall below the specified range at 158 °F (+70 °C) ($V_{MPP +158\text{ °F}} > \text{min. input voltage range}$).



NOTE: The Sunny Boy can tolerate a current higher than the specified current as long as the voltage is within the specified range.

7.1.1 Minimum MPP-voltage of the PV panel

Often a fixed lower MPP voltage limit of the inverter is not useful when the cells of the PV panel have very high temperatures. This means the MPP voltage of the PV panel decreases and the inverter cannot feed the maximum power from the PV panel to the low-voltage grid. The inverter remains at the lower limit of input voltage and cannot follow the MPP of the PV panel. Therefore the Sunny Boy has a flexible MPP voltage range.

There is a fixed ratio between the minimum MPP voltage $V_{MPP\ min}$ the Sunny Boy loads onto the PV panel and the grid voltage V_{AC} as shown in **Fig. 7.1**.

Depending on the current grid voltage the minimum DC voltage is assessed and fixed. This flexible MPP voltage range lets the user make optimum use of the specific device characteristics while the energy yield is increased.

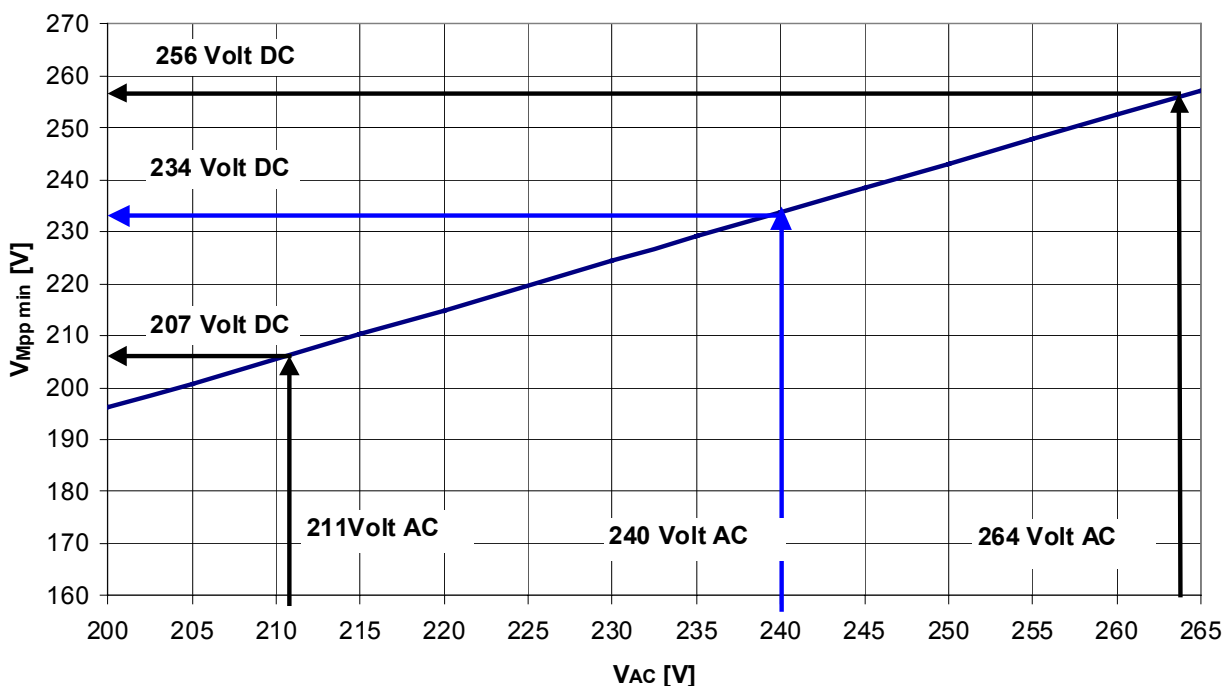

Fig. 7.1: Minimal MPP-voltage as a function of grid voltage

Input Values of the Sunny Boy (DC side)

Input voltage, MPP range (depending on V_{AC}):	V_{PV}	234 V* - 550 V DC
Max. open circuit voltage (under all conditions):	V_{PVOC}	≤ 600 V DC
Max. input current:	I_{PV}	13 A DC
Max. DC power:	P_{PV}	2710 W DC
Recommended PV-panel power:	up to	3000 W _p
Voltage ripple:	V_{PP}	< 10 %
All-pole disconnection on DC side:		optional external DC-breaker
Pole confusion protection:		short circuit diode
Ground fault protection:		ground fault detection($I_{Dif} > 1000$ mA)

* @ V_{ACnom}

Output values of the Sunny Boy (utility side)

Nominal output power:	P_{ACnom}	2200 W AC
Maximal output power:	P_{ACmax}	2500 W AC
Operating range, utility voltage:	V_{AC}	211 - 264 V AC
Operating range, utility frequency:	f_{AC}	59.3 – 60.5 Hz
Total Harmonic Distortion (THD):	THD_{IAC}	< 4 % (with $K_{Vgrid} < 2 \%$, $P_{AC} > 0,5 P_{ACnom}$)
Phase shift (ref. fundamental)	φ	0°
Utility monitoring:		
- Islanding protection:	V_{AC} ; f_{AC}	in accordance with UL 1741
- Ground Fault Protection:	I_{DIF}	in accordance with UL1741
All pole disconnection utility:		independent disconnection (MSD), redundant design (double)
Short circuit protection:		current controlled
Overvoltage classification:		III
Testing voltage (50 Hz):		2.88 kV (1 s)
Testing voltage for surge (1,2/50 μ s):		4 kV (serial interface 6 kV)

External Interfaces

Data transmission via Powerline:	optional
Data transmission via separate cable:	optional; electrically separated RS232 / RS485

Power Consumption

Internal consumption during operation:	< 7 W
Internal consumption during stand-by:	< 0.25 W

Efficiency

Maximum efficiency:	η_{\max} > 94 %
---------------------	----------------------

Ambient Conditions

Tolerable ambient temperature:	-13 °F...140 °F (-25 °C ... +60 °C)
Rel. humidity:	0 ... 100 %, class 3K6

Size & Weight

Enclosure type:	NEMA 4X
Size (w x h x d):	17.08 x 11.61 x 8.42inch (434 x 295 x 214 mm)
Weight:	70 lb. (32 kg)

Certifications:

EMI:	in compliance with FCC regulations, DIN EN 50081, Part 1 (EN 55014, EN 60555 Part 2, EN 55011 group 1, class B) DIN EN 50082, part 1
Utility interaction:	in compliance with UL1741, EN 61000-3-2
Utility monitoring:	in compliance with UL1741, optional: MSD (VDEW; E DIN VDE 0126 (10.97))
Low voltage regulation:	DIN EN 50178 (4.98) (VDE 0160) DIN EN 60146 part 1-1 (3.94) (VDE 0558 part 11)

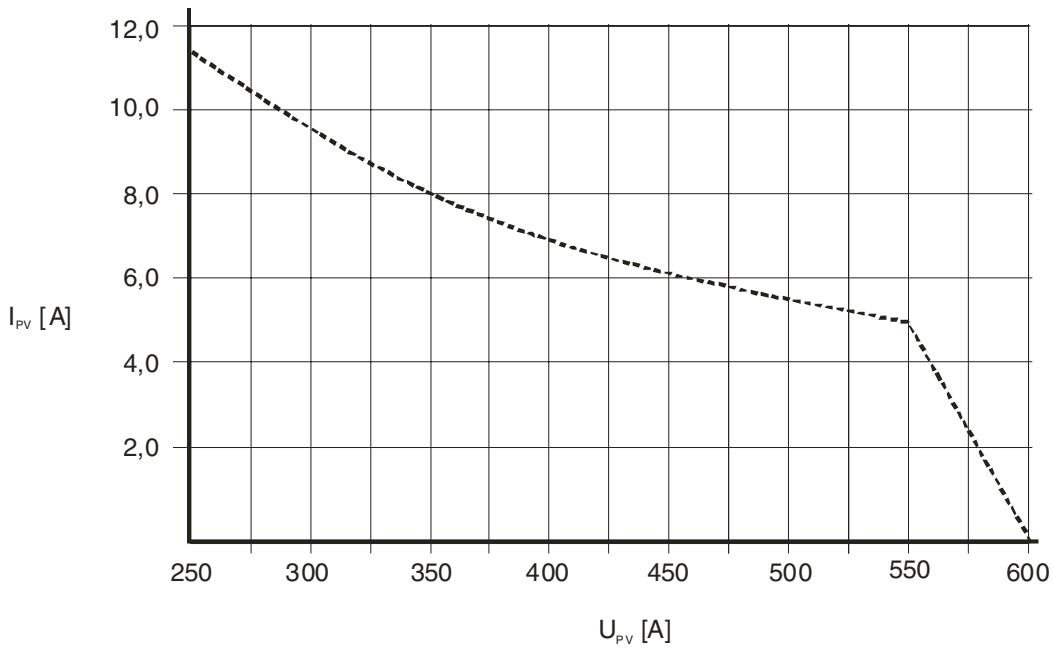

Fig. 7.2: Maximal Input Current of the Sunny Boy 2500U

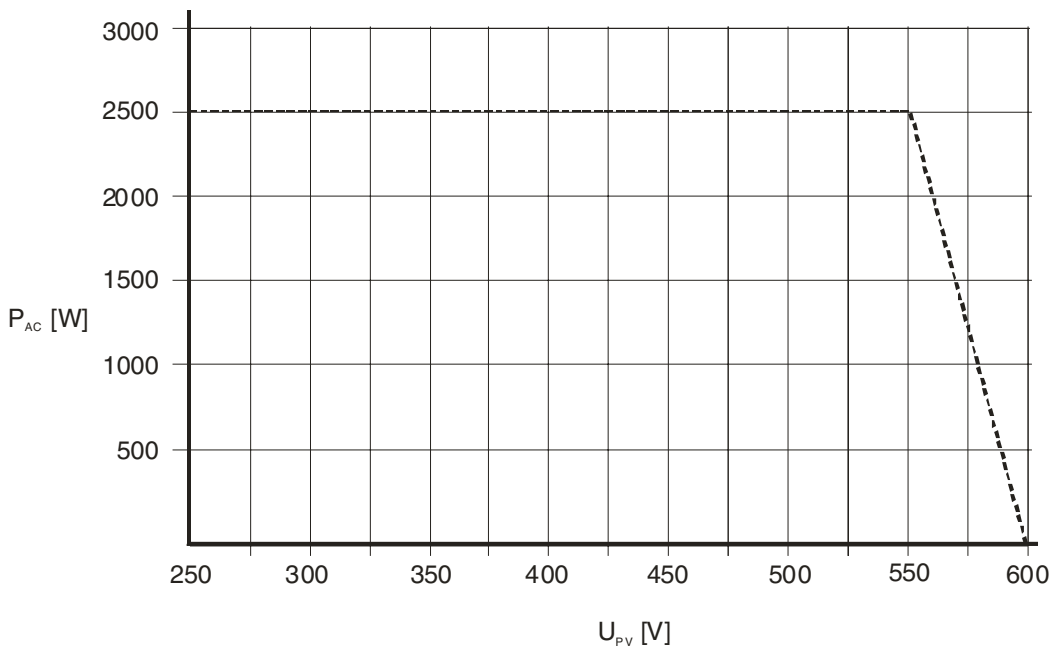

Fig. 7.3: Output Power of the Sunny Boy 2500U

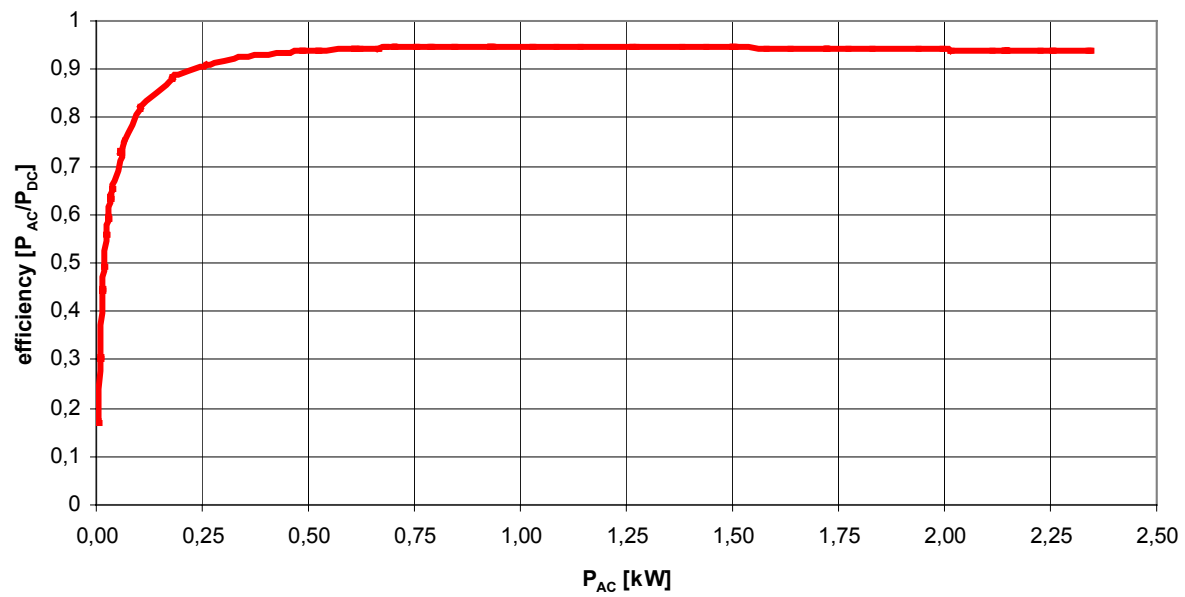

Fig. 7.4: Efficiency of the Sunny Boy 2500U

Parameter List Sunny Boy 2500U

All parameters are transmitted to Sunny Data or to the Sunny Boy Control when the Sunny Boy is configured. The following table shows the available parameters:

No.	Name	Unit	Range		Default	Change by
			from ...	to...		
1	SMA-SN	-				Fixed
2	Vpv-Start	V	250	600	300	Installer
3	T-Start	S	5	300	300	Installer
5	T-Stop	S	1	300	2	Installer
6	V-Const Setval	V	250	600	600	Installer
	Plimit	W			2500	Fixed
23	Testcurrent Zac	MA	0	15000	8000	Installer
28	Vac-Min	V	180	300	213	Installer
29	Vac-Max	V	180	300	262	Installer
30	Fac-delta-	Hz	0	4.5	0.69	Installer
31	Fac-delta+	Hz	0	4.5	0.49	Installer
	dFacmax	Hz / s	0.005	4.0	0.5	Installer
32	Zac-Max	mOhm	0	20000	20000	Installer
33	dZac	mOhm	0	20000	20000	Installer
43	Hardware-BFS	Version				Fixed
44	Software-BFR	Version				Fixed
45	Software-SRR	Version				Fixed
68	Operating mode				MPP-operation	Installer
69	Memory function				no function	Installer
	Default				USA 60Hz	Installer
	Storage				permanent	Installer

Table 7.2: Parameter list Sunny Boy 2500U

8 Appendix

Certificate for Sunny Boy 2500U

- Underwriters Laboratories Listing Document, dated 8 May 2001



333 Pfingsten Road
Northbrook, Illinois 60062-2096
United States Country Code (1)
(847) 272-8800
FAX No. (847) 272-8129
<http://www.ul.com>

NOTICE OF AUTHORIZATION TO APPLY THE UL MARK

Northbrook Office

May 8, 2001

Sma Regelsysteme Gmbh
Attn: Mr Sven Bremicker
Hannoversche Str 1-5
34266 Neistetal Germany

Our Reference: File E210376, Project 00NK8603A
Subject: Sunny Boy SWR-2500U

Dear Mr Bremicker:

We have completed our engineering investigation under the above project number and find the products comply with the applicable requirements.

This letter temporarily supplements the UL Conformity Assessment Services Inspection Procedure and serves as authorization to apply the UL and C-UL Listing Mark, only at the factory under UL's Conformity Assessment Service Program, to the above products, which are constructed as described below:

Identical to the subject model which was submitted to UL for this investigation, the UL records covering the product will be in the Conformity Assessment Services Inspection Procedure, File E210376, Volume 1 based on the completion of the Initial Production Inspection (IPI) that was performed on May 4, 2001.

To provide the manufacturer with the intended authorization to use the UL Mark, the addressee must send a copy of this Notice and all attached material to each manufacturing location as currently authorized in the appropriate UL File Procedure.

This authorization is effective for 90 days only from the date of this Notice and only for products at the indicated manufacturing locations. Records covering the product are now being prepared and will be sent to the indicated manufacturing locations in the near future. Please note that Conformity Assessment Services Procedures are sent to the manufacturers only unless the Applicant specifically requests this document.

Please note: Within Canada, there are federal and local statutes and regulations requiring the use of bilingual product markings. It is the responsibility of the manufacturer (or distributor) to comply with this law. As such, the markings provided in the UL Conformity Assessment Service Procedure may include only the English version. Please contact us if you need assistance with translations or in determining which markings are appropriate for your product.

Products produced, which bear the UL Mark, shall be identical to those evaluated by UL and found to comply with UL's requirements. If changes in construction are discovered, authorization to use the UL Mark may be withdrawn and products that bear the UL Mark may have to be revised (in the field or at the manufacturer's facility) to bring them into compliance with UL's requirements.

Respectfully,

Stephen T Gardner (Ext. 41576)
Sr. Project Engineer
Conformity Assessment Services - 3013MNBK
E-mail: Stephen.T.Gardner@us.ul.com

Reviewed by:

Timothy P. Zgonena (Ext. 43051)
Sr. Project Engineer
Conformity Assessment Services - 3013MNBK
E-mail: Timothy.P.Zgonena@us.ul.com

A not-for-profit organization
dedicated to public safety and
committed to quality service

Information about SMA

Further literature about the Sunny Boy inverter family¹:

- User Manual Sunny Boy 700/850
- User Manual Sunny Boy 1100E
- User Manual Sunny Boy 1700E
- User Manual Sunny Boy 2000
- User Manual Sunny Boy 2500U
- User Manual Sunny Boy 3000
- User Manual Sunny Data
- User Manual Sunny Data Control
- User Manual Sunny Boy Control
- User Manual SWR-COM Socket Powerline Modem
- Sunny Boy Info (periodical newsletter with up-to-date information)
- SMA CD (products, technical documentation, driver)
- Manual "Improved Powerline Communication with the Sunny Boy Family"

Sunny Boy in the Internet:

All documentation and software concerning the Sunny Boy products is available on the Internet - <http://www.SMA.de/>

¹ This literature can be ordered from SMA for a small fee - most of this although is available free of charge for download from www.SMA.de

Our Sunny Boy Homepage is updated daily and offers:

- the newest information concerning the Sunny Boy inverter family
- the newest software
- help concerning problems with your PV-plant
- and of course all you might want to know about SMA Regelsysteme

Those who want to know more about SMA Regelsysteme GmbH and its products are very welcome to visit us on our homepage.

SMA in the USA:

- Address: **SMA America Inc.**
20830 Red Dog Road
Grass Valley, CA 95945
- Telephone: 530.273.4895
- Telefax: 530.274.7271
- eMail: info@sma-america.com
- Internet: <http://www.sma-america.com>

SMA in Europe:

- Address: **SMA Regelsysteme GmbH**
Hannoversche Straße 1 - 5
D-34266 Niestetal
- Telephone: 0049-561 / 9522 - 0 (operator)
0049-561 / 9522 - 499 (Sunny Boy Service)
- Telefax: 0049-561 / 9522 - 100 (main fax)
0049-561 / 9522 - 4699 (Sunny Boy Service)
- eMail: <mailto:info@SMA.de>
- Internet: <http://www.SMA.de>

Appendix: drilling template