



# **BYD Battery-Box HV Installation Guidance**

**Battery-Box H 5.0/7.5/10.0**

Version2.0

---

# Content

<b>1 Safety</b> .....	<b>1</b>
<b>2 Information</b> .....	<b>5</b>
2.1 Product Overview .....	5
2.2 Appearance dimension.....	5
2.3 BCU Module Introduction .....	6
2.3.1 Left side of BCU .....	6
2.3.2 Right side of BCU .....	7
2.3.3 Definition of BCU Functional Interfaces.....	7
2.4 Description of B-Plus H 2.5.....	8
2.5 Delivery contents.....	8
<b>3 Preparation</b> .....	<b>8</b>
3.1Preparation.....	8
3.1.1Installation Instructions .....	8
3.1.2Tools & safety gears required.....	9
3.1.2.1 Tools.....	9
3.1.2.2 Safety gears for personal protection.....	9
3.2 Unpacking the package.....	10
3.2.1 Unpacking.....	10
3.2.2 Items in the package .....	10
3.2.3 Separate BCU and base.....	11
3.3 Adjust the level of the base.....	12
3.4 Install battery modules and BCU .....	12
3.5 Install the hangers.....	13
3.6 Open the top cover of the BCU .....	14
3.7 Power Cables, Ground Cable, Communication Cable & LAN Cable Connection. ....	15
3.8 Install the cover of BCU.....	18
<b>4 Checking List</b> .....	<b>18</b>
<b>5 Run and shut down the Battery-Box HV system</b> .....	<b>20</b>
5.1 Switch on the Battery-Box HV system .....	20
5.2 Updating and Configuration of the Battery-Box HV via web interface .....	20
5.2.1 Login the Battery-Box HV web interface .....	21
5.2.2 Update the latest software of Battery-Box system .....	22
5.2.3 Configuration system information .....	23
5.3 Other functions of the webpage .....	25
<b>6 System Shutdown</b> .....	<b>30</b>
<b>7 Contact</b> .....	<b>31</b>

<b>Appendix : Communication Cable Connections with SMA Inverter .....</b>	<b>31</b>
<b>1 List of matched inverter vendors .....</b>	<b>31</b>
<b>2 Connections with SMA SBS Inverter.....</b>	<b>31</b>
2.1 Pins definition and connections .....	31
2.2 Battery-Box H 5.0-10.0 Connection with SMA SBS Inverter .....	32
2.3 Battery-Box H 5.0-10.0 parameter settings.....	32

## 1 Safety



**This section contains safety information that must be observed at all times when working on or with batteries. To prevent personal injury or property damage and to ensure long-term operation of the batteries, read this section carefully and observe all safety information at all times.**

BYD Battery-Box HV provides a safe source of electric energy when operated as designed.

Potentially hazardous circumstances such as excessive heat or electrolyte mist may occur under improper operating conditions, damage, misuse and abuse.

The following safety precautions and the warning messages described in this section must be observed and complied. If any of the following precautions are not fully understood, or if you have any questions, contact customer service for guidance. Installation and maintenance personnel must review and operate according to applicable federal, state and local regulations as well as the industry standards regarding this product.

All operations of BYD Battery-Box HV relating to electrical connection must be done by professionals.

Please cut off the power supply and turn off the battery in emergency. For example, when there is an emergency such as smoke, fire, burning, explosion, etc.

All batteries store chemical energy and contain electrolyte materials, which are usually a fluid or gel. In the event of an accident which damages the battery casing, electrolyte leakage can create a hazard. At this time, please contact the after-sales service provider for processing.

Please read the quick installation guide and installation manual carefully, and follow the installation steps to complete the installation. If the installation is not carried out in accordance with the requirements and steps, the installer is responsible for the losses caused.

### Skilled personnel only:



This manual and the tasks and procedures described herein are intended for use by skilled personnel only. A skilled worker is defined as a trained and qualified electrician or installer who has all of the following skills and experience:

- a) Knowledge of the function principles and operation of on-grid systems.
- b) Knowledge of the dangers and risks associated with installing and using electrical devices and acceptable mitigation methods.
- c) Knowledge of the installation of electrical devices
- d) Knowledge of and adherence to this manual and all safety precautions and best practices.

## Warning



### **Product harm related warnings:**

The system switch should only be engaged once the system is ready to be commissioned.

The BCU software must be updated to the latest version during commissioning.

In case any issue arises during commissioning, the system must be shut down immediately and reported to the after sales service.

Observe all safety information of the inverter.

During loading, unloading and handling of the product, be cautious, and avoid accidents of product damage and personal injury due to the falling of product.

Please do not stack up batteries without protective package when storing or handling batteries, unless in the case of installation.

When there is a UV3 alarm in the batteries history, the system must be stopped. Continued use may cause material damage to property or to the user personal health. The after-sale service partner should be contacted immediately.

The battery can be stored from UV1 to UV3 for a month. When the battery appears UV1 alarm and the inverter cannot charge the battery, or when the set mandatory charging point is reached, the inverter does not charge the battery, please contact the after-sales service partner immediately. A solution must be found and go to the site to resolve it within a month. Otherwise, the battery will be damaged and unusable.

If the system does not work properly, please contact the after-sales partner in a timely manner and provide relevant abnormal or fault information. The system switch of the battery must be turned off before leaving the site.



### **Human harm related warnings:**

High Voltage Storage! Improper handling can cause danger and damage.

Do not touch any live components.

Ensure that disconnected devices can't be reconnected.

Cover or isolate any adjacent live components.

When disassembling the system, avoid touching the battery terminal with any metal objects or human body.

All work relating to electrical connections of the system shall be carried out by qualified personnel only.

When adding battery, first disconnect the power supply of the battery and other power input.

To avoid danger, do not remove the BCU or battery module when the system is in operation.

The battery must be powered off and disconnected from the inverter and the load during installation and maintenance for our products.

Continuous operation on a damaged battery can result in dangerous situation that may cause severe injury due to electrical shock.

Installers must ensure the installation connections and settings are correct before activating the whole system.

Avoid product damage and human injury during loading, unloading and handling of the products.

Installation workers may not wear metal accessories, etc. in order to avoid short circuit and personal injury.

Wear high voltage insulating gloves when installing the battery system.

If you smell a pungent odor or electrolyte. Please stop the use of the system immediately, and then contact the after-sales service provider.

Do not disassemble the battery modules.

Do not touch the battery pack with wet hands.

Do not crush, drop or puncture the battery.

Do not short circuit the terminals, remove all jewelry items that could produce a short circuit.



**Warning:**

When adding a new battery module, please contact after-service providers and carry it out according to the instruction released by BYD.

You must read the inverter installation manual carefully before matching the battery system with the inverter.

If the battery is deformed or damaged please do not use it and report it to the after sales service.

Batteries must be installed and maintained by qualified installers or technicians.

The battery system has the function of protecting from overcharging. When the protective function fails, please do not continue to charge the battery and report it to the after sales service , so as to avoid personal or material damages.

Always dispose according to local safety regulations.

Store and recharge battery according to user manual strictly.

Ensure reliable grounding.

Do not reverse polarity.

Once the protective packaging has been removed please do only stack the batteries as specified in this guide to avoid damage to the external surfaces

Do not stack up batteries without package.

The packed batteries are not allowed to be stacked up more than specified layers stipulated on the package.

Do not expose the battery to temperature above 50°C.

Do not place the battery near any heat sources and avoid sparks.

Do not expose the battery to moisture or liquids.

Stay away from corrosive gases and liquids, as well as radiation.

Do not expose the battery to direct sunlight.

Place battery in secure location away from children and animals.

Do not allow the battery power terminals to touch conductive objects such as wires.

The Battery-Box HV system can be installed at altitudes of up to 2000m above Mean Sea Level.

The battery system shall be installed in a ventilation location and reserved for at least 0.9m safe passage distance.

Due to the heavy weight of Battery-Box H 5.0-10.0, please use strong packaging and safety protection equipment during transportation, to ensure safety and avoid accidental damage.

Battery cabling should be kept as short as possible to reduce voltage drop at high currents.

In the process of transportation and storage, the goods are not allowed to be stacked in layers or at a height greater than specified.

The installation should be clean, flat, and dry. Not be installed in damp situations, including:

- ☛ Baths, showers and other fixed water containers
- ☛ Swimming pools, paddling pools and spa pools or tubs
- ☛ Fountains and water features
- ☛ Saunas
- ☛ Refrigeration rooms
- ☛ Sanitization and general hosing-down operations

In domestic dwellings, batteries shall not be located in habitable rooms. Habitable rooms including, but are not limited to, the following:

Bedroom, lounge room, living room, music room, television room, kitchen room, dining room, sewing room, study, playroom, family room, home theatre, sunroom, bathroom, toilet room, laundry room.



### **Temperature requirement**

Following installation pictures are some common issues you may meet, some are right and some are wrong. Please pay attention to it.

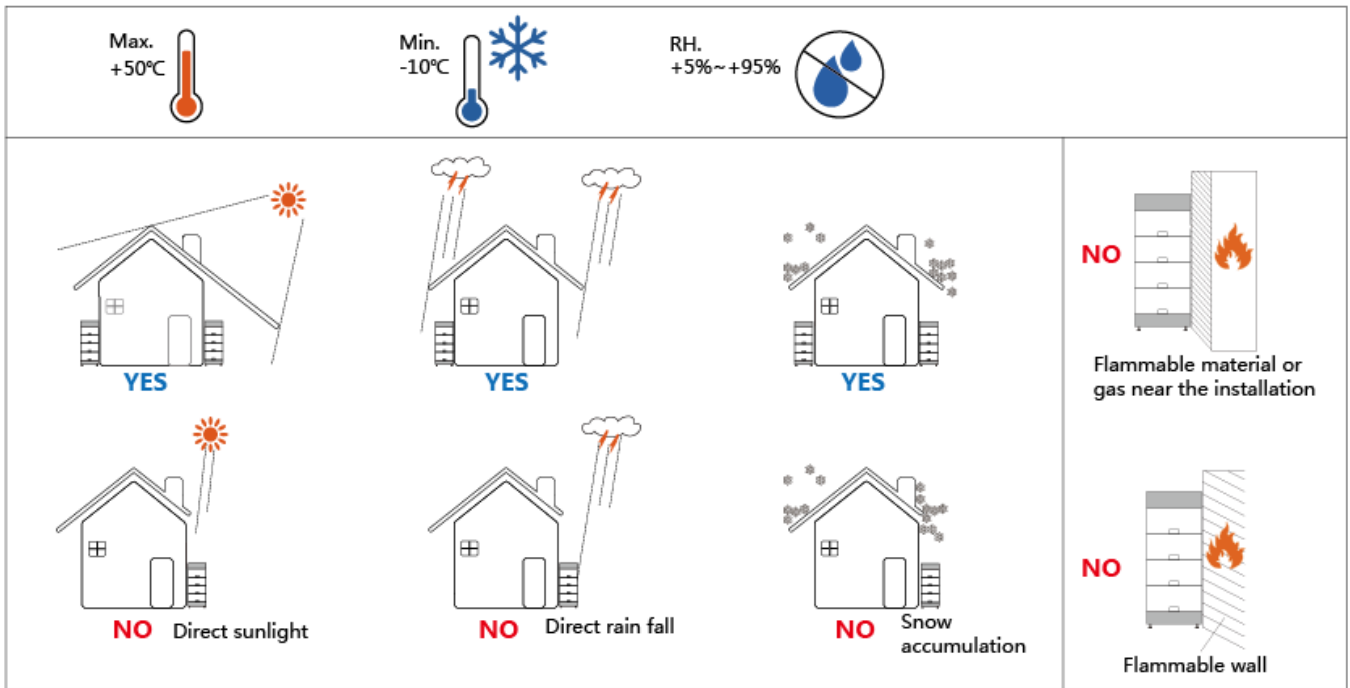

If the ambient temperature is outside the operating range, the battery pack stops operating to protect itself.

Frequent exposure to harsh temperatures may deteriorate the performance and life of the battery pack.



For more safety requirements, please install in accordance with local laws and regulations.

## 2 Information

### 2.1 Product Overview

Battery-Box H 5.0-10.0 is the abbreviation of high-voltage battery box, with the operating voltage range within 200~500V. It is applied to the household energy storage field and works together with high-voltage inverter to realize energy storage and release. Each set of battery of the system supports the serial connection of 2-4 battery modules.

### 2.2 Appearance dimension

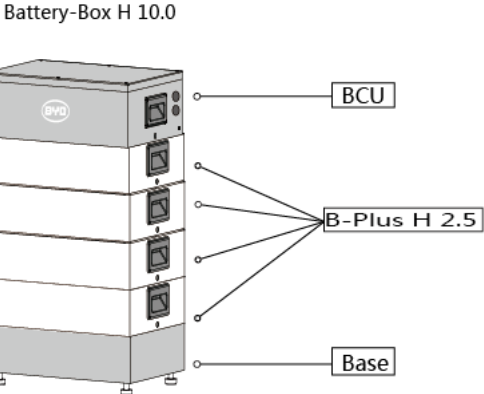
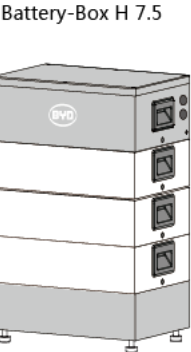
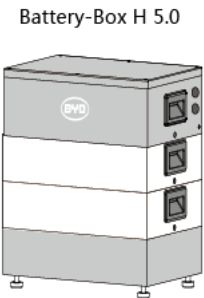
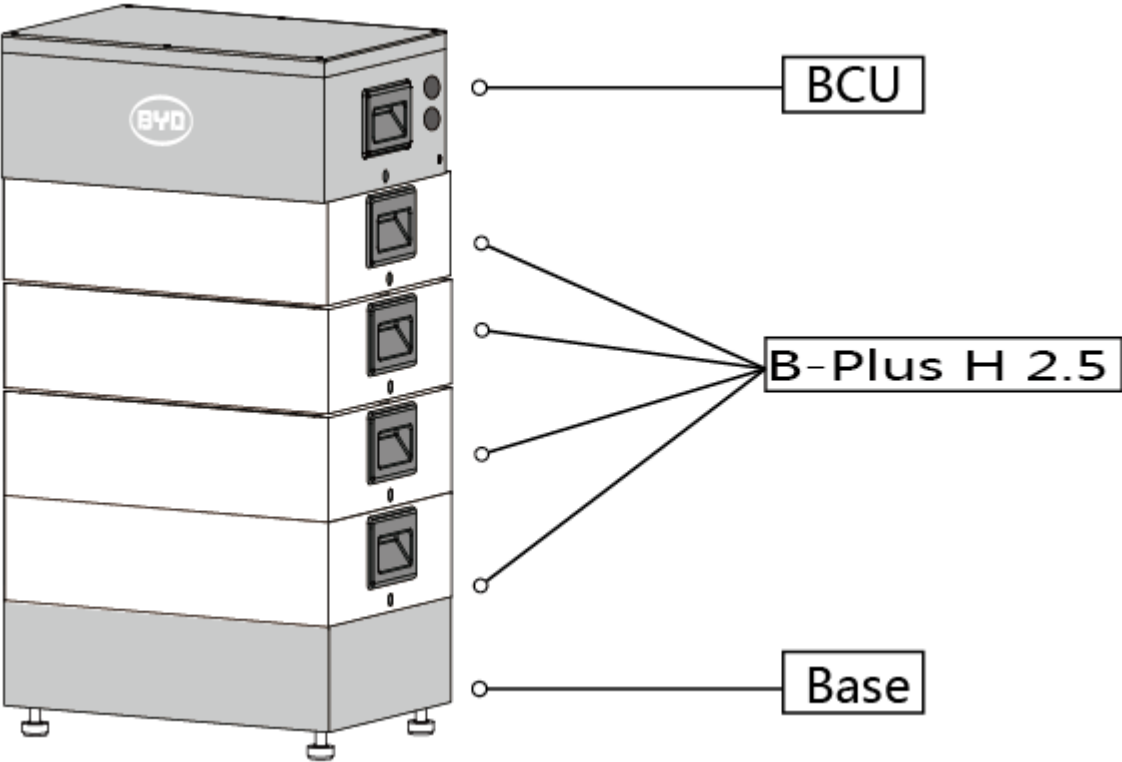

### 2.3 BCU Module Introduction

The BCU (Battery Control Unit) is the management or control part of a battery tower. It contains the circuit board and a system switch. It can be connected to the towers battery modules underneath and to an inverter or a different BMU above.

#### 2.3.1 Left side of BCU



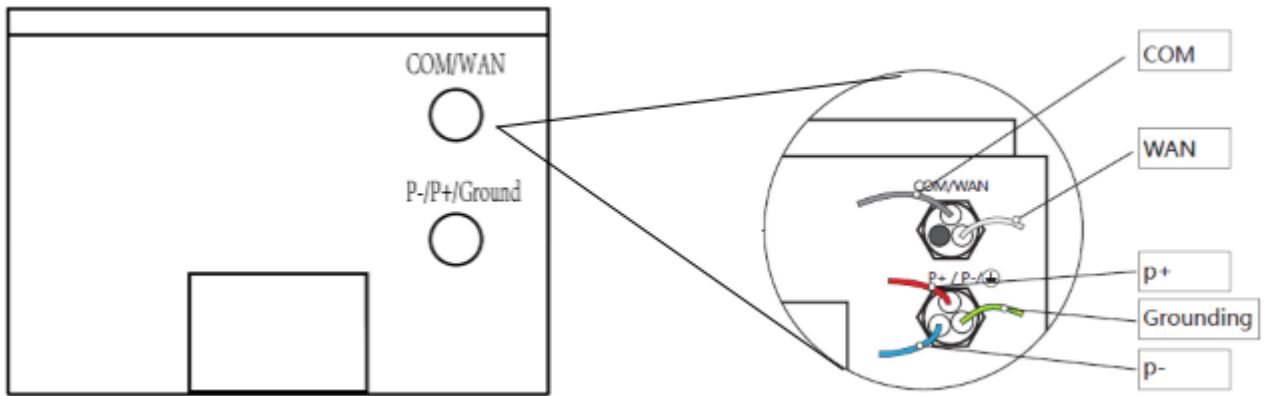

### 2.3.2 Right side of BCU



Position	Designation
A	System switch waterproof cover
B	System switch

### 2.3.3 Definition of BCU Functional Interfaces

No.	Interface Name	Description
1	P+	The system positive terminal, connected to the positive terminal of battery interface of inverter.
2	P-	The system negative terminal, connected to the negative terminal of battery interface of inverter.
3	GND	Grounding terminal, connected to the ground.
4	WAN	Connected to the Ethernet, to complete the functions of communication and remote program update.
5	COM	Contain RS485, CAN, and enable signals, outputting 13V power.

## 2.4 Description of B-Plus H 2.5

The battery modules B-Plus H 2.5 can be used to store and provide energy. They have to be located in the middle of a tower in between the BCU and the base module. Consisting of batteries and the BIC circuit board inside the module sends information about the cell voltage and the temperature to the connected BCU above.

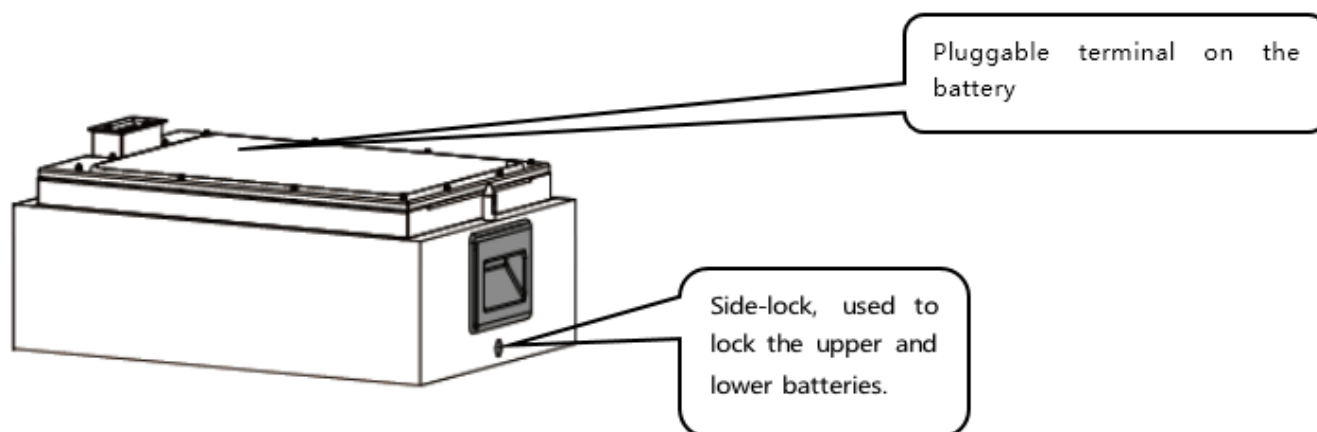

## 2.5 Delivery contents

Type	5.0KWh	7.5KWh	10.0 KWh
BCU + Base	1	1	1
B-Plus H 2.5	2	3	4

## 3 Preparation

### 3.1 Preparation

#### 3.1.1 Installation Instructions



- a) Before installation, ensure that BCU system switch is turned off.
- b) Wear appropriate labor protection products before installation.
- c) The battery shall be installed in a place away from heating source and avoid sparks. The safety distance is greater than 1 m.
- d) The connecting cables for installing batteries shall be as short as possible, to prevent excessive voltage drop.

- e) Batteries of different capacity, different P/N or from different manufacturers cannot be connected.
- f) After installation, ensure the ground cable, communication cable, positive and negative cables of BCU and inverter are connected correctly.
- g) The installation place shall be on a flat ground, without accumulated water.
- h) Batteries must be installed and maintained by qualified installers or technicians.
- i) In order to ensure the normal operation of the Battery-Box, please be sure to update the firmware to the latest version and finish the configuration on Battery-Box webpage in accordance with this document or quick reference guide.
- j) Please make sure the system switch is off in case the system is not working.
- k) The installation and correct working mode should be finished in any case within one week to avoiding overdischarge or other irreversible damages.

### 3.1.2 Tools & safety gears required

#### 3.1.2.1 Tools

The following tools are required to install the battery and BCU.

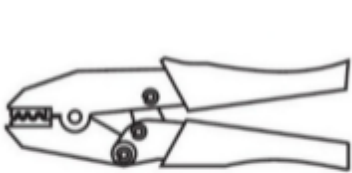

Wire clamp



Precision screwdriver

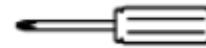

Phillips screwdriver



Levelling instrument

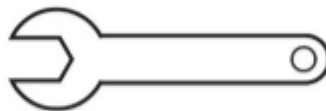

Open-ended wrench

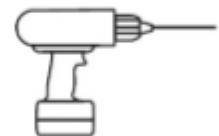

Churn drill

#### 3.1.2.2 Safety gears for personal protection



High Voltage Storage! Improper handling can cause danger and damage.

Wearing suitable personal protective equipment for all work on the product.

It is recommended to wear the following safety gears when handing the battery and BCU.

Safety shoes: In the installation process, when the battery accidentally dropped, can act as a buffer to protect the foot.

High voltage insulation protective gloves: prevent high voltage, protect human life.



Insulated gloves



Safety shoes

### 3.2 Unpacking the package

The battery, BCU and base are packed in separate carton. Before installation, the installation personnel shall read the system configuration list.

#### 3.2.1 Unpacking

Tools: Knife

BCU + Base

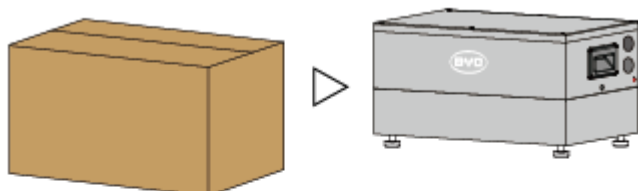



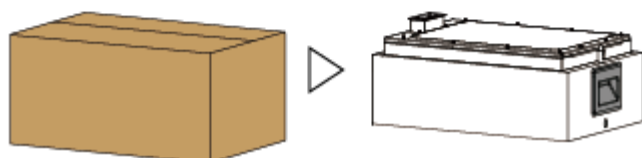



\*n=2 , 3 , 4 B-Plus H 2.5|

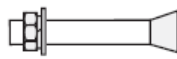

#### 3.2.2 Items in the package

Packing of BCU & BASE

Name	Quantities	
M6 hex screwdriver	6	
M6X50 expansion bolt	3	
M5 OT terminal for P+/P- grounding	4	
Sealing plug black	3	
Sealing plug white	2	
Quick installation guide	1	
User manual	1	
Notice	1	

Packing of B-plus H 2.5		Picture
M6 hex screwdriver	2	
Sealing plug white	2	
MSDS	1	

### 3.2.3 Separate BCU and base

BCU & Base are locked and packed in the same box, unlock the lock with precision screwdriver, separated the BCU and the base. BCU and Base are locked together with anchor bolts, disassemble all the anchor bolts with adjustable wrench.

Tools: M6 hex screwdriver

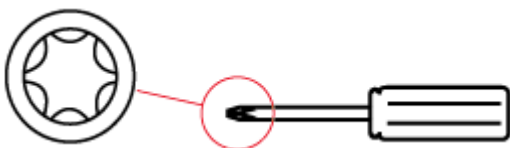

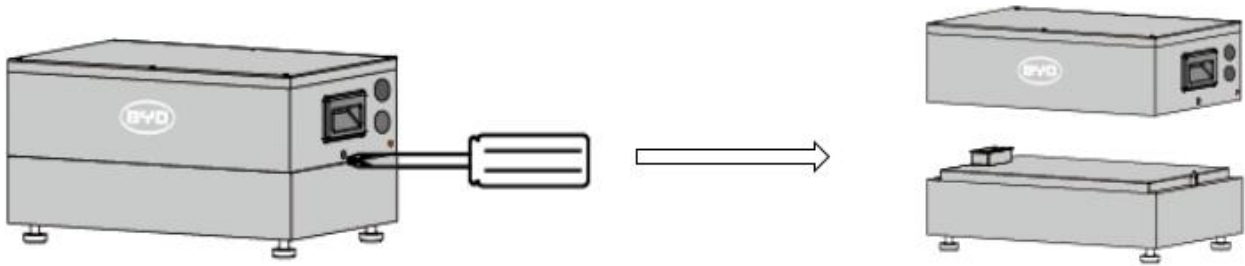

### 3.3 Adjust the level of the base

The anchor bolts should be screwed into the lower part of the base at first. The installation distance from the base module to the wall should be between 0mm and 63mm. The anchor bolts can be adjusted in height to levelize the base module. Counter nuts should be tightened to fix the anchor bolts.

Tools: Inclinator (Level) , Wrench

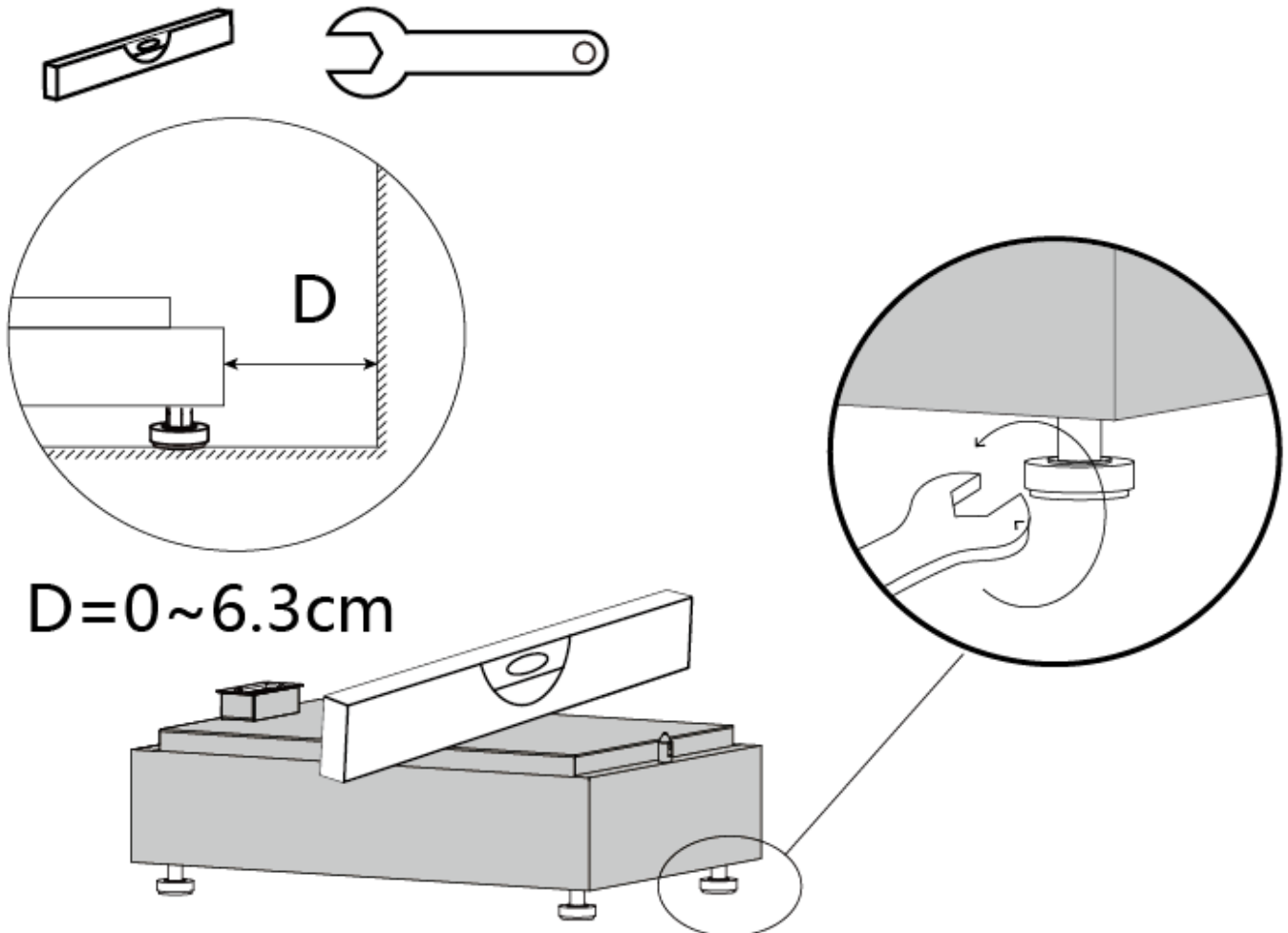

### 3.4 Install battery modules and BCU

The battery modules should be installed on top of the base module. Each module should be carefully placed on the top of the lower one and the side-locks should be closed using the inner

hexagon spanner. Avoid collision of the connectors and corners. After installing all battery modules the BCU module should be placed at the top of the tower and also be fixed with the side-locks.

Tools: churn drill, M6 hex screwdriver

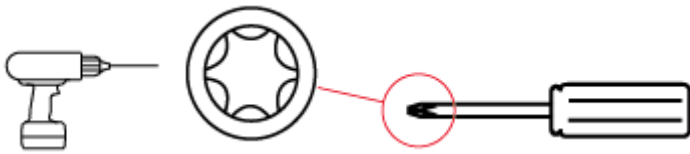

### Install battery modules and BCU

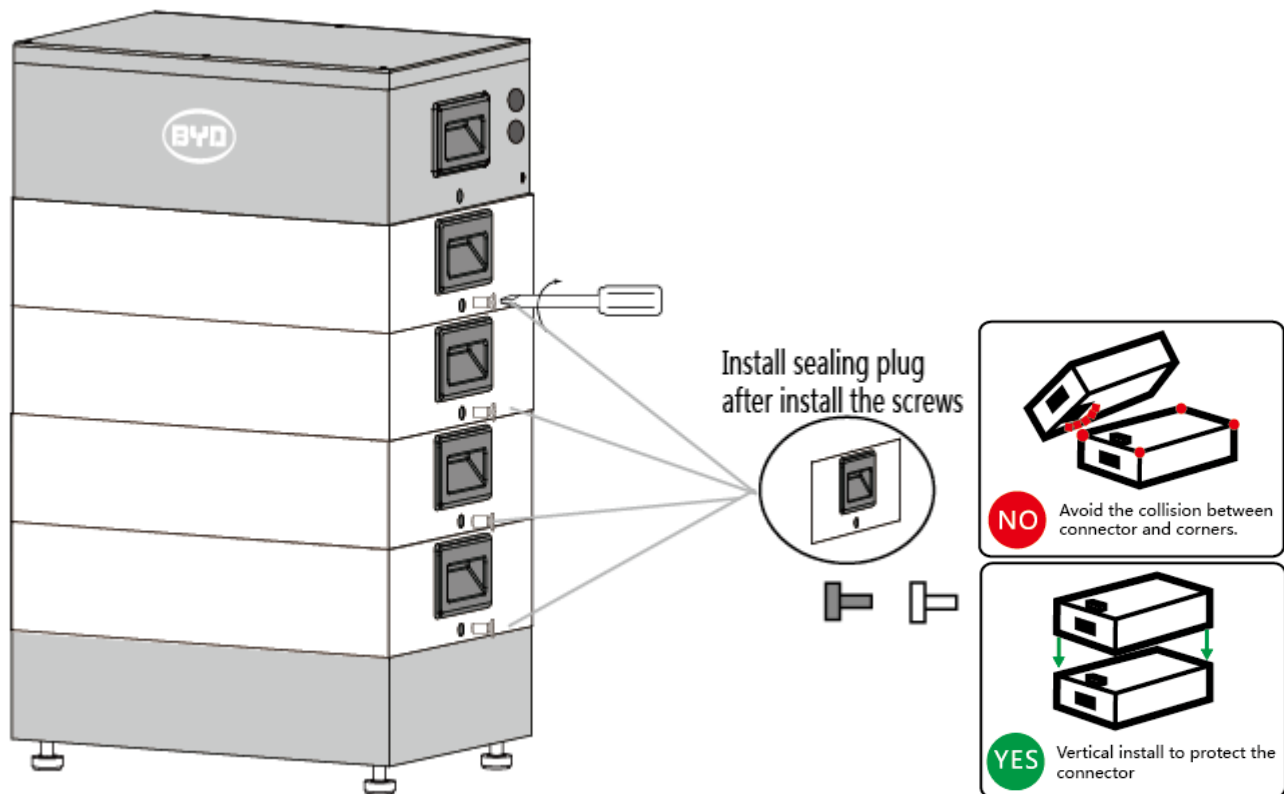

Avoid collision of the connectors and corners

### 3.5 Install the hangers

Tools: Churn drills , Pencil, M6 hex screwdriver



- 1 Use a pencil to mark the location of the hole to be drilled.
- 2 Remove the BCU, punch holes in the wall with hammer drill.
- 3 Install expansion bolt in punched holes.
- 4 Install the BCU, then lock the crews and expansion bolt.

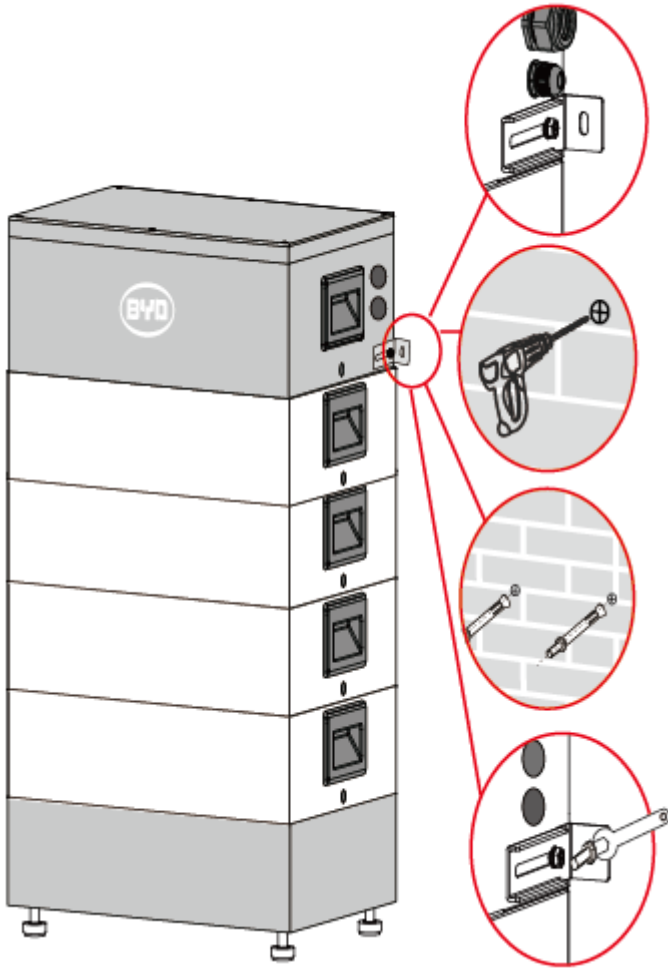

### 3.6 Open the top cover of the BCU

To demount the cover of the BCU the Phillips screws around the edge has to be screwed out. Ensure that the seal of the cover is not broken when demounting and mounting the cover. This is needed to ensure IP 55 protection level. - Warning: The system switch of the BCU should be turned off when opening the cover. Danger of high voltage.

Tools: M6 hex screwdriver





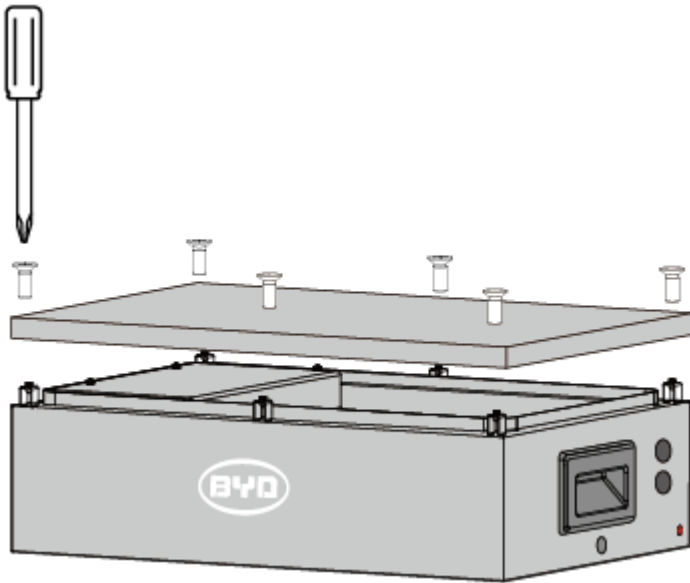

### 3.7 Power Cables, Ground Cable, Communication Cable & LAN Cable Connection.

After demounting the cover of the BCU the circuit board can be seen. Warning: Touching anything else than the terminals or scratching the circuit board with tools may damage the whole system. Due to high voltage it may be dangerous to life to get in contact with the circuit board. The system switch must be turned off when working on the circuit board.

Tools: Phillips screwdriver, Wire clamp



The cables must comply the recommended cable standard shown in the table below. The connection has to be realized according to regional technical standard. --- The connection sequence at the BCU should be: 1. Ground cable (attached to the case), 2. Negative cable (P- Terminal on circuit board, 3. Positive cable (P+ Terminal on circuit board), 4. Communication cable, 5. Network cable. --- The pin assignment of the Communication cable is depended on the inverter in use and shown in the relevant chapter.

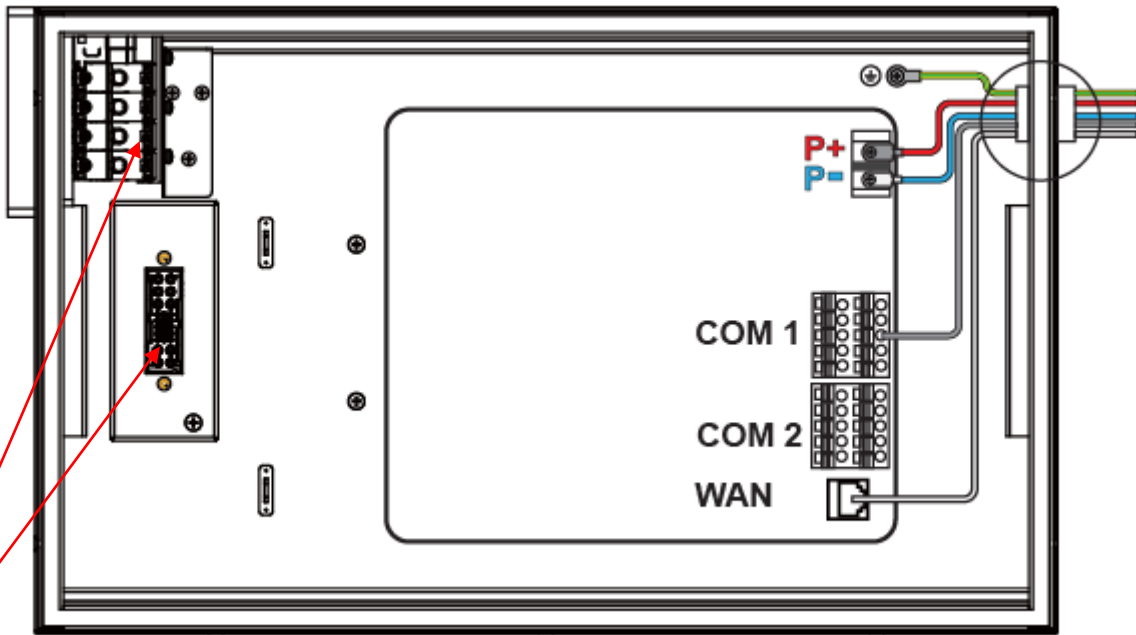

High Voltage even if system switch is off.

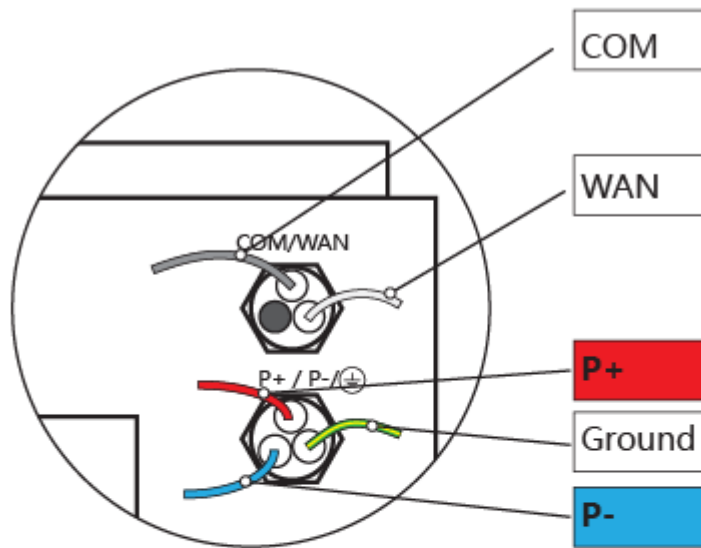

P+,P- cables & Groud  
 $\phi 4\text{mm}-6.8\text{mm}$

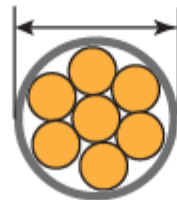

cross-section of cable  
 $S=6\text{mm}^2$

Function of the cables connected with external devices:

No.	Interface Name	Description
1	P+	The systems positive terminal. Must be connected to the inverters positive terminal for battery.

2	P-	The systems negative terminal. Must be connected to the inverters negative terminal for battery.
3	GND	Grounding terminal. Must be connected to the common ground. Do not connect it to the ground on the inverter.
4	Ethernet	Connected to the Ethernet, to complete the functions of communication and remote program update.
5	Inverter communication	Contain RS485, CAN, and EN enable signals, outputting 13V power.

The COM1 and COM2 terminals share the same pins. The table below show the pin assignment.

**BYD Battery-Box HV**

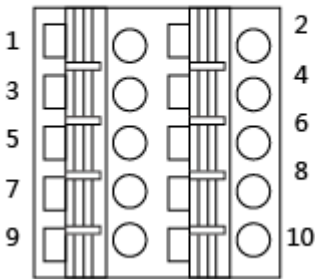

Pin	Definition	Description
1	13V+	Positive terminal of 13V output
2	EN 11V+	Positive terminal for inverter enable signal interface
3	13V-	Negative terminal of 13V output
4	EN 11V-	Negative terminal for inverter enable signal interface
5	RS485A	RS485 Bus
6	CANH	CAN-Bus
7	RS485B	RS485 Bus
8	CANL	CAN-Bus
9	Shield	Shield line
10	NC	Reserved



CAN\_H and CAN\_L use twisted-pair.

**Cable standard recommended**

Cable definition	Cable diameter (mm)	Sectional area (mm <sup>2</sup> )	Recommended cable type
------------------	---------------------	-----------------------------------	------------------------

P+ connection cable	Φ4~Φ6.8	6	UL1015 10AWG
P- connection cable	Φ4~Φ6.8	6	UL1015 10AWG
Grounding cable	Φ4~Φ6.8	6	UL1015 10AWG
Communication cable	Φ4~Φ6.8	/	cat5e or above
Ethernet cable	Φ4~Φ6.8	/	cat5e or above



1. If there are relevant local cable technical standard requirements, please use the local standard.
2. After accomplishing the installation, the wiring should be double checked. You can use the checking list in chapter 4 for this. Please check steps 1-13.

### 3.8 Install the cover of BCU

Before mounting the cover of the BCU again the installed cables should be checked if they are connected well. Mounting the cover the seal should not be harmed to ensure IP55 protection level. All screws of the cover should be tightened carefully to prevent them from harm.

Tool: M4 Phillips screwdriver

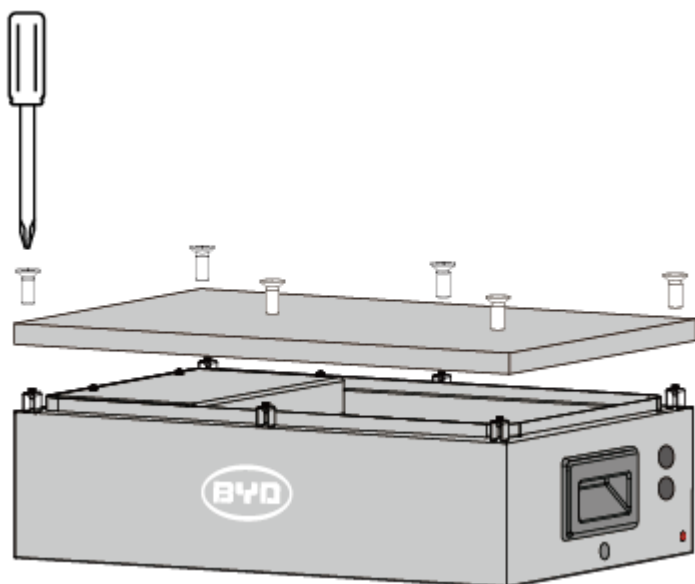
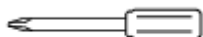

## 4 Checking List

The purpose is to check the connection and parameters setting between the Battery-Box H 5.0-10.0 and the inverters. The above inspection is only related to BYD Battery-Box HV. For other inspection, please refer to the inverter user manual and installation manual.

After installation, please check following items according to quick reference manual.

Task	Check
1 Sealing plug of batteries and BCU	<input type="checkbox"/> Yes <input type="checkbox"/> No
2 hangers of BCU	<input type="checkbox"/> Yes <input type="checkbox"/> No
3 Positive cable connection	<input type="checkbox"/> Yes <input type="checkbox"/> No
4 Negative cable connection	<input type="checkbox"/> Yes <input type="checkbox"/> No
5 Ground cable connection	<input type="checkbox"/> Yes <input type="checkbox"/> No
6 Network cable connection	<input type="checkbox"/> Yes <input type="checkbox"/> No
7 Communication cable connection	<input type="checkbox"/> Yes <input type="checkbox"/> No
8 CAN_H and CAN_L use twisted-pair	<input type="checkbox"/> Yes <input type="checkbox"/> No
9 Ground cable, power cables and communication cable have a reliable connection and there is no short circuit.	<input type="checkbox"/> Yes <input type="checkbox"/> No
10 Update the latest software (Via BYD Battery-Box HV web)	<input type="checkbox"/> Yes <input type="checkbox"/> No
11 Installation time and country and inverter type and battery' s quantity correctly setting on Battery-Box HV web	<input type="checkbox"/> Yes <input type="checkbox"/> No
12 Battery-Box type and parameters correct setting on inverter' s web or App.	<input type="checkbox"/> Yes <input type="checkbox"/> No



Turn off the inverter and battery system switch before installation;

Confirm the power cables are not connected reversely;

Ensure reliable and correct connection of communication cable between battery and inverter.

Make sure communication cable connection follows the requirement of different types of inverters.

After connecting the wires according to the installation manual, gently pull down each wire to ensure that it is secure;

Before power on the system the wiring must be double checked if it' s done correctly;

Use twisted-pair wire for CAN\_H and CAN\_L, which will help to improve the stability of CAN communication.

## 5 Run and shut down the Battery-Box HV system

Note: Before activating the system, please check the following items:

Confirm the inverter is not connected reversely;

Ensure reliable connection of communication cable between battery and inverter.

Warnings: The battery must work together with an inverter. If the battery, the inverter or the whole system is not used, please keep the system switched off. Leaving the system turned on may lead to deep discharge and harm the battery.

### 5.1 Switch on the Battery-Box HV system

1. Before switch on the system switch, make sure all connections are correct.
2. Open the system switch waterproof cover of BCU.
3. The battery-box system can be turned on by operating in the direction indicated by the system switch.
4. The system switch is the final on-off switch of the battery-box system. The BCU will be powered on by the battery.

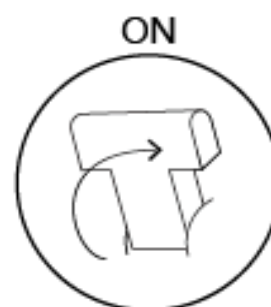
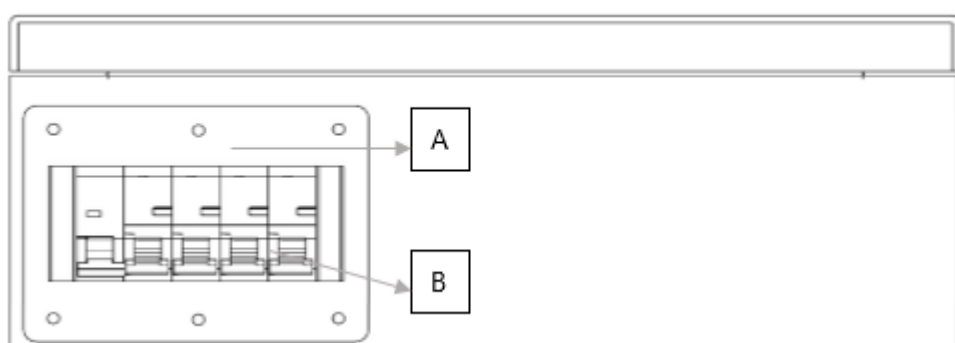

### 5.2 Updating and Configuration of the Battery-Box HV via web interface



The commissioning of the battery system and the inverter has to be finished on the same day. The battery must not left switched on, if there is an interruption of the commissioning process. This might lead to a deep discharge of the battery and harm the battery system or even damage it permanently.

The commissioning procedure is finished if there is a normal communication with the inverter and the ability to charge the battery. In case of any interruption the batteries system switch should be turned off before leaving the side. --- After the mechanical and electrical installation of the batteries and the BCU, the system has to be configured using the Battery-Box HVs web interface.

--- 1. Update the latest software. 2. Configure the system information (Installation time,

installation country, inverter type, number of batteries) 3. Reboot the system (Both the update and the configuration are restarted automatically). 4. Configuration of the inverter.



The installer shall bear the consequences and losses arising from the failure to operate in accordance with the above requirements, and BYD shall not bear the consequences and losses arising therefrom.

### 5.2.1 Login the Battery-Box HV web interface

There are three ways to log in to the Battery-Box HVs web interface. Using one of the browsers (Microsoft Internet Explorer, Google Chrome, Mozilla Firefox) is recommended. The installers initial account number and password are as follows. (Login ID: installer; password: byd@12345).

#### 1. WIFI

Turn the main switch of the Battery-Box on to power on the battery system. 2. Connect the computer to the Battery-Box systems WIFI. Search in the computer for new WIFI networks. The name of the WIFI will be BYD and the last 11 numbers of the serial number. (Example: Products serial number: "BYD100171708-00000" will have the WIFI name: "BYD171708-00000") WIFIs password is "123456789". 3. Open a recommended browser and call the IP address of the Battery-Box where you are usually put in the URL of a web page. The Battery-Box IP address is "192.168.5.1" 4. You will be asked for account number and the login password. Please fill in "installer" and as a password "byd@12345".

#### 2. LAN

The LAN cable has to connect the Battery-Box with the router. Your computer has to be connected with the same router to be in the same LAN. 2. Turn on the main switch of the Battery-Box system. The Battery-Box IP address will be shown on the routers web page. 3. You can access the Battery-Box web interface calling in a recommended browser the IP address, or its host name. The host name is "BYD" and the last 11 numbers of the serial number.(E.g. Product serial number "BYD100171708-00000" will have the host name "BYD171708-00000") 4. You will be asked for account number and the login password. Please fill in "installer" and as a password "byd@12345".

#### 3. Direct connection with network cable

The LAN cable has to be connected directly to your computer. 2. Turn on the main switch of the Battery-Box system. 3. Set your computers IP address on the same subnet like the Battery-Box IP address. (E.g. Computer IP address: 192.168.6.100) 4. Enter the IP address of the Battery-Box system in the recommended browser "192.168.6.1" and call the page. 5. You will be asked for account number and the login password. Please fill in "installer" and as a password "byd@12345". After successful login the web interface will look like shown below. Please read the privacy statement carefully before operating the Battery-Box HV system.

## Privacy Policy

### Battery-Box HV

Privacy Policy

Installation

Home

Device Information

Installation Config

Statistics Information

Current Alarm

History Alarm

Run Data

Set Password

Update

### Privacy Policy of BYD Lithium Battery Co., Ltd

#### Responsible for data processing (controllers):

BYD Lithium Battery Co., Ltd  
 Represented by Wang Chuanfu  
 No.1, Baoping Road  
 Baolong Industrial Town  
 Longgang Shenzhen  
 518116, P.R.China  
 E-Mail: eubatterygrp@byd.com  
 Phone: +86 0755 89888888

(in the following "BYD")

In case of a claim arising of the BYD Battery-Box Limited Warranty Letter, the BYD Authorized Service Partner may process your personal data in his own responsibility but acting as an auxiliary agent of BYD:

EFT-Systems GmbH  
 Represented by Juan Carlos Alonso  
 Buchenstr. 37  
 D-97816 Lohr am Main

### 5.2.2 Update the latest software of Battery-Box system

To update the Battery-Box with the latest software, you should click on "Update" in the left bar. A web page appears which allows you to browse for the update file. Please upload the file from your computer and then click "Upgrade" to finish the updating process. After updating the system will restart automatically. Please wait patiently. It can take up to some minutes. --- The newest software will be available on the webpage of the after-sales-service provider of the Battery-Box. In the appendix you will find the web address depending on your region.



After updating, the system will restart automatically, please wait patiently.  
 Download the firmware: [www.eft-systems.de\(Support->Downloads\)](http://www.eft-systems.de(Support->Downloads))





### Update

- Battery-Box HV**
- Privacy Policy
- Installation
- Home
- Device Information
- Installation Config
- Statistics Information
- Current Alarm
- History Alarm
- Run Data
- Set Password
- Update

Please import the file:

If there is any new version on the server, clicking  will update the system.

### 5.2.3 Configuration system information

Click on the "Installation" menu in the left list to set the system's user information (e.g. the installation time and date, the server IP, the quantity of batteries, the type of inverter, the geographic location. etc.). The number of B-Plus H 1.28 (according to actual modules of the system, 4~9pcs), inverter model (e.g SMA, KOSTAL etc.).



These parameters are crucial for the proper work of the system. They must be configured correctly. Incorrect information may lead to damage of the system.



- Battery-Box HV**
- Privacy Policy
- Installation
- Home
- Device Information
- Installation Config
- Statistics Information
- Current Alarm
- History Alarm
- Run Data
- Set Password
- Update



Time and Date \*    Hour:     Min:     Day:     Month:     Year:



Battery-Box HV
Privacy Policy
Installation
Home
Device Information
Installation Config
Statistics Information
Current Alarm
History Alarm
Run Data
Set Password
Update



Server IP Address *	<input type="text" value="bboxserver.byd.com.cn"/>
Series Battery Counts *	<input type="text" value="4"/>
Inverter *	<input type="text" value="SMA"/>
Country *	<input type="text" value="null"/>

Asterisk (\*) indicates required fields

After clicking on “Finish” button on the step 3, the system will set the parameters automatically. Please wait patiently for about one minute and ensure that the system will not be powered off. If the system is powered off the configuration might fail.



Battery-Box HV
Home
Device Information
Statistics Information
Current Alarm
History Alarm
Run Data
Set Password
Installation Config
Inverter Information
Update
Reboot and Restore

**Reboot System...**  
Please wait about 50 seconds.



Note: After setting, the system will be restarted automatically.



\*Warning: Incorrect configuration can lead to malfunction of the system and might cause damage.  
\*If the system is not working, please switch off the air switch of Battery-Box H 5.0-10.0 before leaving to avoid further damage.

When the system restarts successfully, you can check the “ Installation Config” page to see if the configuration is successful. If the configuration is not successful, you need to reconfigure it

### 5.3 Other functions of the webpage

- 1) Main information page "Home" --- Clicking on "Home" in the left bar the user can view the main battery information such as voltages, the actual current and the systems temperature. The page also shows the SOC and the alarm state.

**Battery-Box HV**

- Privacy Policy
- Installation
- Home
- Device Information
- Installation Config
- Statistics Information
- Current Alarm
- History Alarm
- Run Data
- Set Password
- Update

**Home**

**Battery Information :**

Total Voltage:	212.695	V
PackVoltage:	0.000	V
Current:	0.012	A
SOC:	89.600%	
SysTemp:	22.400	°C
MaxCellVol:	3.325	V
MinCellVol:	3.322	V
MaxCellTemp:	22.200	°C
MinCellTemp:	21.600	°C
Power:	0.000	KW
System state:	IDLE	
Date and Time:	2019-01-28 13:52:55	

**Alarm state:** Normal!

- 2) Device Information  
Clicking on "Device Information" in the left bar the user can view the main device information such as serial numbers, firmware version and the main network information.

**Battery-Box HV**

- Privacy Policy
- Installation
- Home
- Device Information
- Installation Config
- Statistics Information
- Current Alarm
- History Alarm
- Run Data
- Set Password
- Update

**Device Information**

**Machine**

SN:	401011908-00002
Factory time:	2019-1-22 9:49:57
Version:	V3.012 R

**Board**

SN:	BH06S0739SLL000832
Factory time:	2018-10-29 19:48:4

**Network**

wlan0	192.168.5.1
eth0:2	192.168.6.1

**Restore SOC calculation**

SOC calculation:

**Battery capacity calibration**

Battery capacity calculation:

**Download battery data**

Battery data:

**Software release records**

V2.004B	---	12.01.2018
V2.005B	---	12.02.2018
V2.008B	---	03.04.2018
V2.010B	---	18.04.2018
V3.001R	---	20.04.2018
V3.003R	---	25.05.2018
V3.004R	---	09.07.2018
V3.007R	---	13.09.2018
V3.008R	---	19.09.2018
V3.010R	---	21.11.2018
V3.011R	---	27.12.2018
V3.012B	---	15.01.2019



After running for a period of time (usually more than 30 days), the Battery-Box HV automatically performs capacity calibration functions on a regular basis to ensure the accuracy of the battery SOC, and most inverters that match the Battery-Box HV can support the battery capacity calibration function.

The battery performs capacity calibration with the cooperation of the inverter. the calibration process needs to fill and discharge the battery, so it may have some impact on the normal use of the user, and return to normal after the calibration process.

In addition to automatic calibration of the system, you can force calibration by manually clicking the Battery capacity Calibration button on the web management page of the battery in the following cases:

1. After the inverter and battery are installed for the first time, the whole system works normally, and a capacity calibration can be done to make the capacity calculation more accurate.
2. After the battery module is replaced, a capacity calibration can be performed to make the capacity calculation more accurate.
3. During use, if you find or think SOC is inaccurate, you can click the Battery capacity Calibration and SOC Calibration button.



In manual forced calibration, the system should be allowed to charge and discharge normally according to this strategy until the end of the process. SMA and Kostal don't

have this feature, but Fronius and Goodwe do. Kostal and SMA do not support this feature unless BYD and Inverter manufacturers update information

3) Installation Config

Clicking on "Installation Config" in the left bar the user can view the main installation information like the Servers IP Address, Array counts (which is the number of Battery-Box towers), Series Battery Counts (which is the number of battery modules in the tower), Installation Time, Inverter Type and the set Country.

**Battery-Box HV**

- Privacy Policy
- Installation
- Home
- Device Information
- Installation Config
- Statistics Information
- Current Alarm
- History Alarm
- Run Data
- Set Password
- Update

**Installation Config**

Server IP Address :	bboxserver.byd.com.cn
Array Counts :	1
Series Battery Counts :	4
Installation Time :	2019-1-26 9:23:3
Inverter :	SMA
Country :	null

4) View charging and discharging records

Click the 'Statistic information' on the left, the user can check the total charging and discharging data, and the charging and discharging history as well.

**Battery-Box HV**

- Privacy Policy
- Installation
- Home
- Device Information
- Installation Config
- Statistics Information
- Current Alarm
- History Alarm
- Run Data
- Set Password
- Update

**Statistics Information**

**General Information**

Total Charge Energy:	10.671 KWH
Total Discharge Energy:	7.438 KWH
Total Cycle Counts:	1

<b>Specific Information</b>								
No.	Type	AH	KWH	EnvTemp	BatTemp	StartTime	EndTime	
1	Discharge	1.0	0.216	21.8	25.0	2019-1-24 11:38:30	2019-1-24 11:39:51	
2	Charge	1.0	0.223	21.4	25.0	2019-1-24 9:46:10	2019-1-24 9:52:48	
3	Discharge	0.2	0.047	21.3	25.0	2019-1-24 9:43:4	2019-1-24 9:44:32	
4	Charge	23.2	6.212	31.0	36.3	2018-12-4 9:29:35	2018-12-4 10:55:35	
5	Discharge	23.5	6.017	30.5	33.5	2018-12-4 8:25:52	2018-12-4 9:25:51	

5) View current alarm

Click the 'Current Alarm' on the left, the user can check the current alarm of the system.

**Battery-Box HV**

Privacy Policy  
Installation  
Home  
Device Information  
Installation Config  
Statistics Information  
**Current Alarm**  
History Alarm  
Run Data  
Set Password  
Update

**Current Alarm**

No.	Alarm Name	Main	Sub1	Sub2	Alarm Level	Alarm StartTime

6) View history alarm

Click the 'History Alarm' on the left, the user can check the history alarm.

**Battery-Box HV**

Privacy Policy  
Installation  
Home  
Device Information  
Installation Config  
Statistics Information  
Current Alarm  
**History Alarm**  
Run Data  
Set Password  
Update

**History Alarm**

No.	Alarm Name	Main	Sub1	Sub2	Level	Alarm StartTime	Alarm EndTime	Reason
1	BatteryBreak	1	1	1	3	2019-1-28 9:33:23	2019-1-28 9:33:23	PowerDown
2	SysRestart	1	1	1	1	2019-1-26 9:23:3	2019-1-26 9:23:3	Record
3	SysRestart	1	1	1	1	2019-1-26 9:19:3	2019-1-26 9:19:3	Record
4	BatteryCommErr	1	5	1	3	2019-1-26 9:19:1	2019-1-26 9:19:3	PowerDown
5	BatteryCommErr	1	6	1	3	2019-1-26 9:19:1	2019-1-26 9:19:3	PowerDown
6	BatteryCommErr	1	7	1	3	2019-1-26 9:19:1	2019-1-26 9:19:3	PowerDown
7	BatteryCommErr	1	8	1	3	2019-1-26 9:19:1	2019-1-26 9:19:3	PowerDown
8	BatteryCommErr	1	9	1	3	2019-1-26 9:19:2	2019-1-26 9:19:3	PowerDown
9	BatteryCommErr	1	5	1	3	2019-1-26 9:9:15	2019-1-26 9:13:27	PowerDown
10	BatteryCommErr	1	6	1	3	2019-1-26 9:9:15	2019-1-26 9:13:27	PowerDown
11	BatteryCommErr	1	7	1	3	2019-1-26 9:9:15	2019-1-26 9:13:27	PowerDown
12	BatteryCommErr	1	8	1	3	2019-1-26 9:9:16	2019-1-26 9:13:27	PowerDown
13	BatteryCommErr	1	9	1	3	2019-1-26 9:9:16	2019-1-26 9:13:27	PowerDown
14	HardwareFault	1	1	1	3	2019-1-26 9:13:27	2019-1-26 9:13:27	PowerDown
15	BatteryBreak	1	1	1	3	2019-1-26 9:13:27	2019-1-26 9:13:27	PowerDown
16	BatteryCommErr	1	5	1	3	2019-1-25 14:37:16	2019-1-25 14:42:16	PowerDown
17	BatteryCommErr	1	6	1	3	2019-1-25 14:37:16	2019-1-25 14:42:16	PowerDown
18	BatteryCommErr	1	7	1	3	2019-1-25 14:37:16	2019-1-25 14:42:16	PowerDown

7) View Run Data

Choosing the modules individually in the drop down menu "Series Battery Num", the data of each module can be seen. The data shown is the actual sensor data of each temperature

and voltage sensor in the battery module. One is able to analyze the voltages even down to cell level. The number of the module is defined by the serial number of the battery modules in the tower. The serial number shows the production week of a module with the four digits in the middle after "1C". The last digits of the SN show a rising number per production week. (E.g. Serial number: "PGM00001903-1C361708-00125" - The module had been produced in year 2017 and week 36. It was the 125th module produced in this week.)

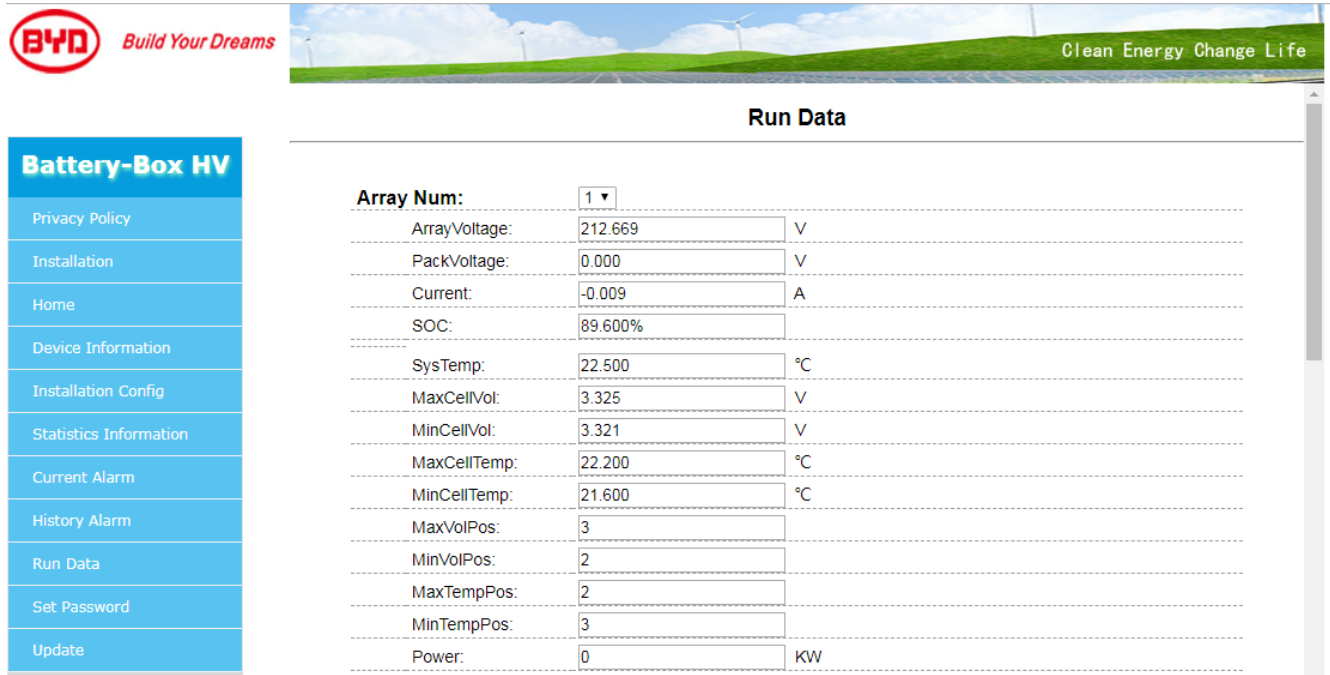

Run Data		
Array Num:	1	
ArrayVoltage:	212.669	V
PackVoltage:	0.000	V
Current:	-0.009	A
SOC:	89.600%	
SysTemp:	22.500	°C
MaxCellVol:	3.325	V
MinCellVol:	3.321	V
MaxCellTemp:	22.200	°C
MinCellTemp:	21.600	°C
MaxVolPos:	3	
MinVolPos:	2	
MaxTempPos:	2	
MinTempPos:	3	
Power:	0	KW

#### 8) Set the password

Click the "Set Password" on the left, the user can set the new password. If the password get lost that the customer couldn't log in to the Battery-Box HV web interface.

#### 9) If you forget your password, contact your after-sales partner, and eventually BYD will help reset the password. In order to ensure your normal use, please remember your password.



### Set Password

Password:

Confirm Password:

## 6 System Shutdown

To shut down the whole system it is important to follow this sequence. --- 1. Loads and inputs at the inverter should be shut off. 2. Switch off the inverter according to the inverters manual. 3. Switch off the system switch of the Battery-Box. (Left hand side of the BCU) 4. After stopping the whole system please ensure that the a) inverter is powered off. b) the battery system is powered off.



If it is intended to not use the system for a longer time, make sure the batteries system switch is properly turned off. At this point, the SOC of the system should be kept at a higher SOC to prevent the battery from overdischarge. The requirements of storing the battery modules should be respected.





## 7. Contact

If you have technical problems with our products, please contact the customer service partner .The following data is required in order to provide you with the necessary assistance:

- Battery system:
  - Type
  - Serial number of BCU and each Batteries
  - Quantities of battery
  - Software version of BCU
  - Event message and Error discription
  - Mounting location
  - Installation date(for the first time) and Installation environment(out door or indoor) and ( recent 5 days temperature when OT or UT alarm happened )
  - \_ Field treatment process
- Battery inverter:
  - Device type
  - Serial number
  - Firmware version
  - Event message
  - Use the name and account and password of the system in inverter remote monitoring (if available)
  - Type of automatic transfer switch (if available)
  - Optional equipment, e.g. communication products
  - Access data for Inverter remote monitoring (if available)
  - Special country-specific settings (if available)

## Appendix : Communication Cable Connections with SMA Inverter

### 1 List of matched inverter vendors

Serial number	name
1	SMA SBS 3.8/5.0/6.0

### 2 Connections with SMA SBS Inverter

The installation method of the inverter may be changed. Please refer to the installation instructions for the inverter.

#### 2.1 Pins definition and connections

Pins from BYD Battery-Box	Definition	Pins from SMA inverter SBS	Definition
2	EN 11V+	B	Enable
4	EN 11V-	C	GND and shielding
6	CANH	E	CAN H

8	CANL	D	CAN L
10	NC	A	Not assigned
1	13V+	F	12V+
3	13V-		
5	RS485A		
7	RS485B		
9	Shield		

## 2.2 Battery-Box H 5.0-10.0 Connection with SMA SBS Inverter

The installation method of the inverter may be changed. Please refer to the installation instructions for the inverter.

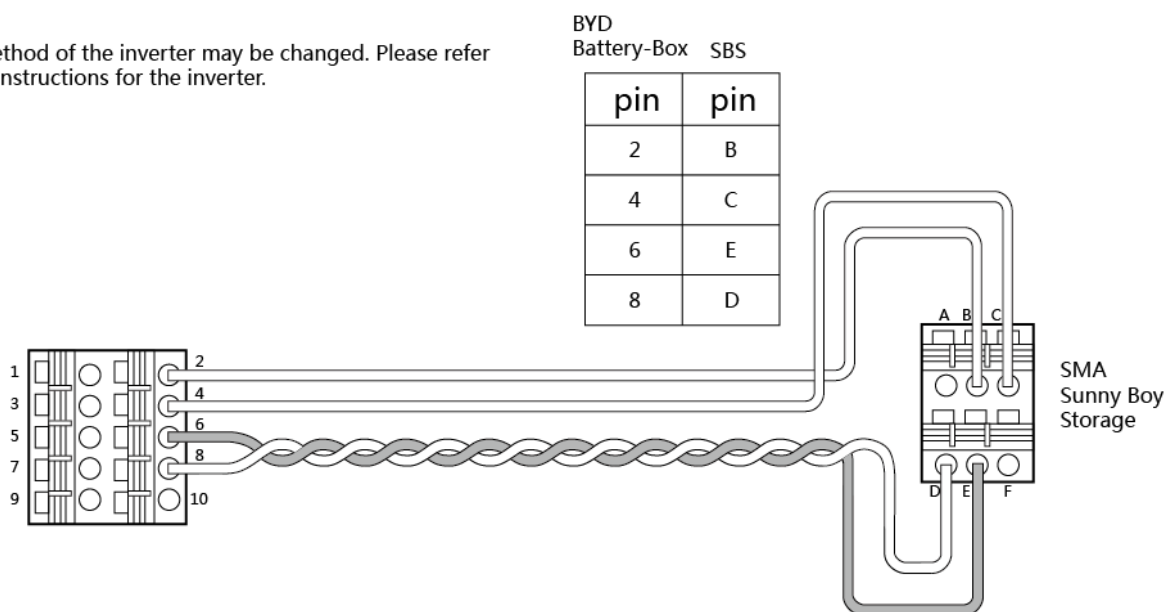

The installation method of the inverter maybe changed. Please refer to the installation instructions of the inverter.

Note: Please define the pins according to the label and number it in right direction!

## 2.3 Battery-Box H 5.0-10.0 parameter settings

The parameters of the battery are set on the web page of the inverter. For other parameters and working modes of the inverter, please refer to the manual of the inverter.

The recommended default minimum settings for batteries are as follows.

No.	SMA SBS Parameters	Default value
1	Battery-Areas-of-application-Lower-Imt-deep-disch.Protect-area-prior-shutdown	2%
2	Battery-Areas-of-application-Minimum-width-of-deep-discharge-protection-area	3%
3	Battery-Areas-of-application-Area-width-for-conserving-battery-sate-of-charge	3%
4	Battery-Areas-of-application-Minimum-width-of-own-consumption-area	100%

## Headquarter

### China

BYD LITHIUM BATTERY Co., LTD

E-Mail: eubatterygrp@byd.com

Tel: +86 0755 89888888

Fax: 0755-8961 9653

Address: No.1 Baoping Road, Baolong Industrial Town, Longgang Shenzhen, 518116, China

## Local Contacts

### US

EFT-Systems GmbH

Customer Service E-Mail: USservice@eft-systems.de;

Telephone: +1(833)338-8721.

Website: www.eft-systems.de

### Europe

EFT-Systems GmbH

Customer Service Mailbox: service@eft-systems.de

Telephone: +49 9352 8523999

Website: www.eft-systems.de

### UK

Storing Renewable Energy

Customer Service Mailbox: info@srenergy.co.uk

Telephone: +44 (0) 2037695998

Website: www.srenergy.co.uk

### Australia

Alps Power Pty Ltd

Customer Service Mailbox: service@alpspower.com.au

Telephone: +61478 140 287

Address: U201 15Chatham Road West Ryde NSW 2114 Australia